

A note on Neighbourhood values using Prime Numbers.

Read this note when you come across neighbourhoods in the text.

If you select the prime numbers **7** and **11**, then the first value that contains both 7 and 11 as factors is the product of **7 x 11** which is **77**.

Now if you wish to use a value less than **77** containing both factors then this is impossible.

Now there is a trick called neighbourhood values that makes it possible to link **7** and **11** as factors.

To solve it, choose the value **21** and its neighbour **22** and the value **55** and its neighbour **56**.

$$7 \times 11 = 77$$

$$21 = 3 \times 7 \text{ and } 22 = 2 \times 11$$

$$56 = 8 \times 7 \text{ and } 55 = 5 \times 11$$

Thus by neighbourhood we can link **7** and **11** without using **77**.

Example to bring the factors **2, 3, 13, 43, 373** together by neighbourhood.

The lowest number possible that divides by each factor is

$$2 \times 3 \times 13 \times 43 \times 373 = 1,251,042.$$

This is called the lowest common denominator.

But by neighbourhood, is there a value below **1,252,042** that will function **1118** with **1119** ?

$$1118 = 2 \times 13 \times 43 = 13 \text{ [One]} \times 86 \text{ [God]} \text{ and } 1119 = 3 \times 373 \text{ [Word]}$$

This used in **Deut 6.4** with **John 1.1**

Use a calculator to verify the above.

Thanks are given to **Vernon Jenkins, Craig Paardkooper, Stephen Coneglan** and to **the Scientist's work of Vladimir shCherbak, Maxim A. Makuov, Miloje M. Rakočević, Jean-Yves BOULAY** & others.

Without their studies I could not have developed this booklet.

The Original Paper of **Vladimir shCherbak & Maxim A. Makuov** can be obtained from me with an A5 Stamped addressed Envelope. *P Bluer.*

You should now watch the DVD or read the **Seven Unusual Numbers** booklet. This will give you the unassailable evidence that you need which proves that the Bible is indeed the true revelation to Mankind. It shows by Prime Numbers that the words in **Hebrew of Genesis 1.1** and the **Greek words of John 1.1** are the exactly the right number of words and letters that there should be. No more and no less !

Now what can we say about the Messiah - Jesus Christ ?

The Religions of Ancient Rome could not compete

with the promise of the God of Israel -

the promise of Eternal life in the Kingdom of God

and with the entrance into his Kingdom having been paid for by the blood of His Christ - **His own Son.**

The Promise is the **free gift** of eternal life.

You cannot work for it. John 6.29

They said to Jesus,

“ What must we do, to do the works of God ?”

Jesus answered them,

“ This is the work of God, that you believe in him whom He has sent.”

All the Prophets from Moses, Isaiah, Jeremiah

never spoke like this Man !

The Prophets all confessed their Sins but this man never gave the slightest hint that he was a sinner, for in Christ the

“ whole fullness of the Deity dwells bodily ” Col 2.9

Also He made the most amazing statements

that no Prophet had ever uttered:

Jesus said to them

“ you will die in your sins unless you believe that I am He ”

“ I say to you, If any one may keep my word, by no means will he taste death in the [coming] age ” John 8.24, 51

“ I am the Resurrection and the life; he who believes in me, though he die, yet shall he live, [at the resurrection of the dead]

and whoever lives [again, in this resurrection]

and believes in me shall never die ” John 11.25

To see the Evidence for why the Bible is True watch the DVD.

All this information and much more is
contained in the book (over 460 pages)

373

A Proof Set in Stone
by Dr Peter Bluer, PhD, BSc [hons]

' 373 A Proof Set in Stone ' @ £14.99 per copy
inclusive P & P
Also a DVD is available £3.99 inclusive P & P

Printed by **Tuition 373 Ltd**

15 Patchcroft Road, Peel Hall, Wythenshawe
Manchester,
M22 5JG, U.K.

Tel 0161 437 7013

E-mail Peter@biblemaths.com

Please make cheque payable to **Dr Peter Bluer**

Air mail , Europe, U.S.A and the

The Rest of the World - See Web site for
Overseas Prices www.biblemaths.com

The Signatures Encoded in DNA and Scripture

**How Gen 1.1, Deut 6.4 & John 1.1
are encoded in DNA**

by Peter Bluer

Other Booklets 1 October 2013	Pages	gram	cost
1. The Seventy Sevens Prophecy of Daniel the Prophet. Invincible Proof that Jesus of Nazareth is the Son of God Sent from Heaven at the time of the Roman Empire	32	40g	50p
2. The Seven Unusual Numbers. Mathematical Proof using Prime Numbers 37 and 73 for an unbelieving Age	32	40g	50p
3. The Seven Unusual Numbers Condensed Version Mathematical Proof using Prime Numbers 37 & 73 for an unbelieving Age	16	20g	25p
4. Evidence. Is the Bible to be trusted, the evidence ? Which is more reliable, Jesus Christ existed or Julius Caesar existed ?	16	20g	25p
5. The Question of the Destiny of Judas Iscariot. A New look at what the Bible actually teaches	24	30g	40p
6. What does the Bible say about Dinosaurs. What does the Bible say about dinosaurs	24	30g	40p
7. Is The Big Bang Theory in Deep Trouble ? Is it the correct explanation of the Origin of the Universe ?	16	20g	25p
8. Special Creation Why I know that Special Creation (the Bible) is the most scientific (logical) explanation for the Origin of life on the Earth and not the theory of Evolution (Darwinism)	16	20g	25p
9. A Proof set in Stone Mathematical Evidence 'π' & 'e' Pi & the 'Exponential constant' Encoded in Gen 1.1 and John 1.1	16	20g	25p
10. The Conspiracy. Why is the word: 'μελλω' 'Soon-about to happen' missing from the Translation of the New Testament ?	44	57g	70p
11. A summary of certain aspects of the Second Advent. A clear exposition of the Second Coming of Christ	24	30g	40p
12. The Eternal Question. The Main Objection to the Existence of God i.e. Why is there so much Evil and Suffering in the World ?	48	60g	75p
13. Everlasting Destruction 2 Thess 1.9 The Bible does not teach an Everlasting conscious Torture in Hell fire by the Creator.	44	57g	70p
14. The Numerical Structure of DNA. How name 'Jesus Christ' 'Gen 1.1' & 'John 1.1' Encoded in the Atomic Structure of DNA	52	64g	75p
15. An Extract Prof Daniel Lamont on "The Second Advent". A sane understanding of Jesus' "The end of the age (world)"	16	20g	25p
16. A Challenge to Atheists. A knowledge of Algebra is required	24	30g	40p
17. The True Identity of Michael the Archangel. Who is He, and what His role is in Salvation ?	28	34g	40p
18. The Destruction of Jerusalem, an absolute irresistible Proof of the Divine Origin of Christianity. 1829 George Peter Halford	48	60g	75p
Pay Cheque to Peter Bluer. Add Second Class Postage, UK only. For Overseas Prices and Shipping—Email peter@biblemaths.com Letter 0 - 100 grams 50p large letter 0 - 100 grams 69p Thick Packet 0 - 1000 grams 260p 101 - 250 grams 110p Booklets A5 are in Colour. Email for Overseas Prices peter@biblemaths.com			

A Numerical Analysis of the Genetic Signatures revealed in the DNA of Living cells and how it relates to the Numerical Signatures in the Scriptures of Gen 1.1, John 1.1 & Deut 6.4

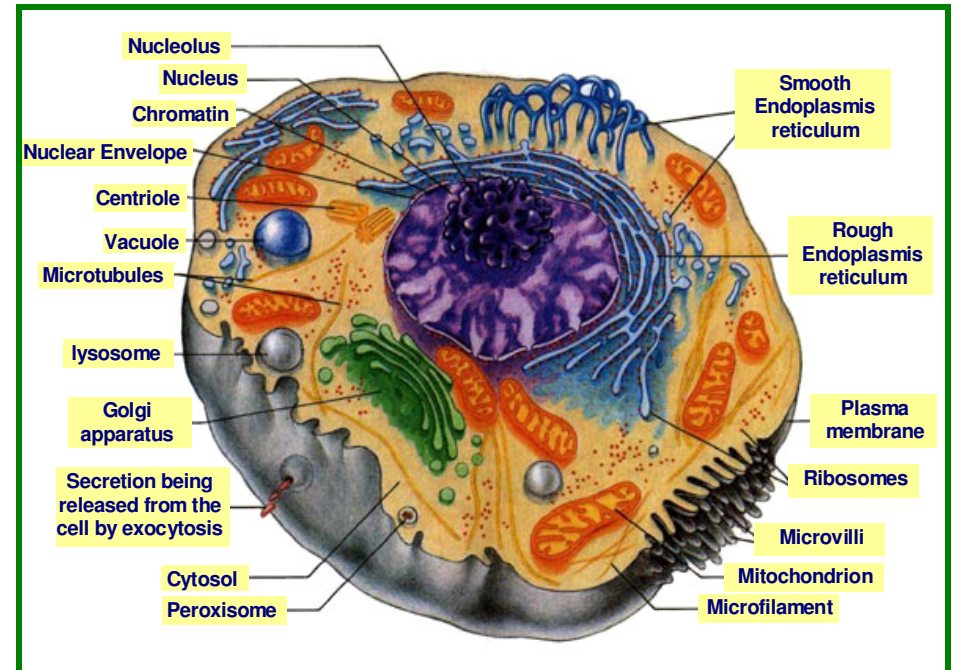

The **Conclusion** of this Booklet, will have **established** the **Evidences**,

1. **The Mathematics of Bible Numerics,**
 2. **The Mathematics of DNA**
 3. **The Blueprints of the Atomic Structure of the Universe,**
- which is **NOW Manifest to all,**
i.e. **The Signature of 37.**

Therefore the **Rational** explanation for this **phenomena** lies in the **Simple Solution** that **God not only exists**, but is also the **Author of all 3 Evidences.** This **Solution** obeys **the Classic rule of Occam's Razor**¹.

1. **Occam's Razor** simply put, is that the **Solution of a complex problem**, more often than not, is **the one** with **the simplest explanation.**

The **Search for Extra Terrestrial Intelligence (SETI)** is the name for a number of activities undertaken to search for **Extra Terrestrial Intelligence** the **SETI** projects, use scientific methods in this search.

For example, electromagnetic radiation is monitored for signals or a signature from transmissions from civilizations sent by **Aliens** on other worlds from outer space whom the vast majority of people actually believe exist. Yes **'believe in'**, basically they have **Faith** that **Aliens must exist**.

The 'WOW' Signal

The Wow! signal was a strong narrowband radio signal detected by Jerry R. Ehman on August 15, 1977, while working on a **SETI** project at **the Big Ear Radio Telescope of The Ohio State University** then located at Ohio Wesleyan University's Perkins Observatory, Delaware, Ohio. The signal bore expected hallmarks of potential **non-terrestrial** and **non-Solar System origin**. It lasted for the full 72-second duration that **Big Ear** observed it, but has not been detected again. The signal has been the subject of significant media attention.

Amazed at how closely the signal matched the expected signature of an interstellar signal in the antenna used, Ehman circled the signal on the computer printout and wrote the comment "Wow!" on its side. This comment became the name of the signal.

Ehman has stated his doubts that the signal is of **intelligent extra terrestrial** origin: *"We should have seen it again when we looked for it 50 times. Something suggests it was an Earth-sourced signal that simply got reflected off a piece of space debris."*

He later recanted his scepticism somewhat, after further research showed an Earth-borne signal to be very unlikely, due to the requirements of a space-borne reflector being bound to certain unrealistic requirements to sufficiently explain the nature of the signal.

Also, the 1420 MHz signal is problematic in itself in that it is **"protected spectrum:"** it is bandwidth in which terrestrial transmitters are forbidden to transmit due to it being reserved for astronomical purposes. In his most recent writings, Ehman resists **"drawing vast conclusions from half-vast data"** acknowledging the possibility that the source may have been military in nature or otherwise may have been a production of Earth-bound humans.

Because of this some scientists say that **Radio signals** are an unlikely method that will be successful. Other scientists believe there is **another way of detection** to find the truth of **extra terrestrial intelligence** which involves **the molecular structure DNA**.

The **reflective Symmetry** displayed is paralleled by the **reflective Symmetry** in the digits of **Gen 1.1** and **John 1.1**

$$\text{Gen 1.1 } 2701 = 37 \times 73 \quad \text{John 1.1 } 3627 = 3 \times 13 \times 31 \times 3 = 39 \times 93$$

All this Symmetry in the Amino Acid's proton count proves beyond any reasonable doubt that Random forces could not create the Universe. The Universe was created by a Mathematician. To deny this shows almost invincible prejudice against anything spiritual.

What conclusion can we draw from this study of these Numerical factors in the **DNA codons**. **It all shouts Signature from an intelligent source!**

The most interesting phenomena are the **Numbers of Creation** which are **7, 13, 26** and especially **37** which are all exhibited in the counting of **the Nucleons** in the **20 Amino Acids**.

You would not expect this kind of Symmetry to exist in a Universe created by the blind forces of Nature. It shows even the invention of zero and the existence of the decimal system. Remember you have by design **10 fingers and 10 toes !**

The arrangement of Nucleons shows a Mathematician at work.

Jesus said **"But the very hairs of your head are all numbered"**

The Scriptures **Gen 1.1, John 1.1** and **Deut 6.4** that give the details of **Creation** and **the Nature of the Godhead**, all agree numerically with the **Signatures** displayed in **the DNA Codons**.

Now we will turn to **the very structure of the Universe**. **The Universe** is made from **Molecules, atoms, neutrons, protons** then ultimately subatomic particles. These particles are called **Electrons, Quarks, Gluons, Photons** etc. It is proposed that **"pure energy"** locked in the **nothing** created these particles based on a number of blueprints called **"Quantum electrical fields."** When the **British actor Ken Campbell**¹ interviewed **The Director of CERN - [European Organization for Nuclear Research]**. **The director** ask **Ken** **"how many blueprints, do you think you need, to create all you see around you."** **Ken** thought for a moment and replied **"perhaps billions of blueprints."**

The Director said **37 "Only 37" — 37 yet again.**

When will we believe!

Ken said **"do you mean the whole show—the Creation of the Universe, could be done with 37 Blueprints"** **The Director** said **"YES"**

I call to your attention that these discoveries have been made by scientists who do not have the knowledge of **the Numerical Structure of the Bible**. It is appreciated that it is difficult to follow all this arithmetic but you can understand the point of all this **Numerical Symmetry in Scripture, the DNA Codons** and **the Atomic Structure**. **God is the Author of all !**

1. Reality on the Rocks part 2, Ken Campbell <http://cdsweb.cern.ch/record/1056264>

Matrices have the same value

Matrices have the same value

Reflection Matrices

Reflection Matrices

2236			
300	296	192	320
300	160	236	376
296	256	320	288
256	192	224	252

2028			
300	296	192	320
300	160	236	376
296	256	320	288
256	192	224	252

2236 = 13 x 172 = 26 x 86

2028 = 13 x 156 = 3 x 26 x 26

Reflection Matrices

Reflection Matrices

2236			
300	296	192	320
300	160	236	376
296	256	320	288
256	192	224	252

2028			
300	296	192	320
300	160	236	376
296	256	320	288
256	192	224	252

1144 = 13 x 88 = 26 x 44

1144 = 13 x 88 = 26 x 44

1092 = 13 x 84 = 26 x 42

884 = 13 x 68 = 26 x 34

Matrices have the same value

2288			
300	296	192	320
300	160	236	376
296	256	320	288
256	192	224	252

The previous Matrices produce this symmetry

1144 = 13 x 88 = 26 x 44

1144 = 13 x 88 = 26 x 44

Signature 13, John 1.1 with its reflective Signatures

3 x 13 x 31 x 3 = 3627

Signature 26, Deut 6.4 with the Divine Name יהוה = 26

Signature 86, Gen 1.1 Hebrew for God Elohim אלהים = 86

By analysing the molecular structure by Arithmetic of DNA (this will be explained later) the scientists have determined that something OUT THERE called "What ever it was" has seeded the Earth with DNA.

The Numerical and Algebraic Structure of DNA shows the invention of the Decimal system, with Positional Arithmetic (hundreds, tens, units etc), the invention of Zero, which are all latecomers to our modern day methods of arithmetic. The DNA's molecular structure shows that the Prime Number 37 is encoded all over the DNA molecule and this is irrefutable evidence, as there is no natural random mechanism to produce this exquisite Structure. So "What ever it was" shows an intelligent origin.

My own observation is there is no mention of the thousands of Molecular machines necessary to make the DNA function which is reproductive, self diagnostic and self repairing mechanism only within the machinery of the cell. They also say that DNA is the most stable recording method known to man! Essentially the structure is digital.

The Scientists would like the SETI Project to use the DNA numerical analysis as a more productive method than the search using Radio Detection.

The following Mathematical DNA pages are a summary of the work of

Vladimir shCherbak and Maxim A. Makuov,

as documented in their papers which are peer reviewed.

"Arithmetic inside the universal genetic code".

"The "Wow! signal" of the terrestrial genetic code". #

Also following pages will show the very same Signature in the arithmetic of DNA, is the Same Arithmetic Signature in Gen 1.1, Deut 6.4, John 1.1 by their designed structures.

The Scientist's research shows an intelligent Structure but does NOT inform us who that was, "What ever it was", but the Algebraic Structure of the Scriptures identifies who this intelligence WAS and IS !

I need first to explain as simply as I can the Chemistry of the DNA molecule and the numerical analysis involved and how it produces a Signature that is indisputable with regards to source that is intelligent.

I am bound to say, that this evidence has been produced NOT by Creationists but Evolutionary Mathematical Biologists.

Alongside this I will explain how the Same Signature is embedded in Bible Mathematics. I have written in another book "373 A Proof Set in Stone", and a booklet "Seven unusual Numbers" with a more comprehensive explanation of Arithmetic of Bible Mathematics.

To obtain the original paper email peter@biblemaths.com

What is The Genetic code and how does it work ?

The **genetic code** carries all the instructions to build **All Life** on this planet. These instructions are found in a macromolecule called **Deoxyribonucleic acid** or **DNA** for short.



The information is passed from cell to cell in the reproductive process and from generation to generation. The DNA molecule is made up of a basic unit called a nucleotide.

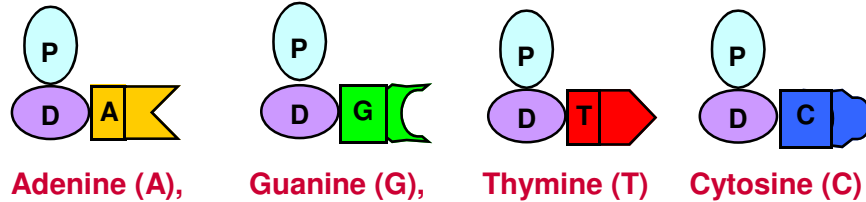
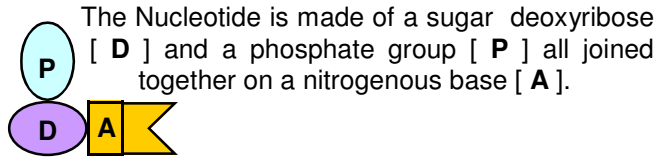

There are just **4** possible nitrogenous bases in the DNA molecule.

The sugar molecule **D** and the phosphate group **P** are bonded together to form a backbone for the nucleotides to ride upon. The backbone carries no information at all. The DNA is in 2 separate halves that are bonded by the 4 nucleotides. The nucleotides only join together as shown.

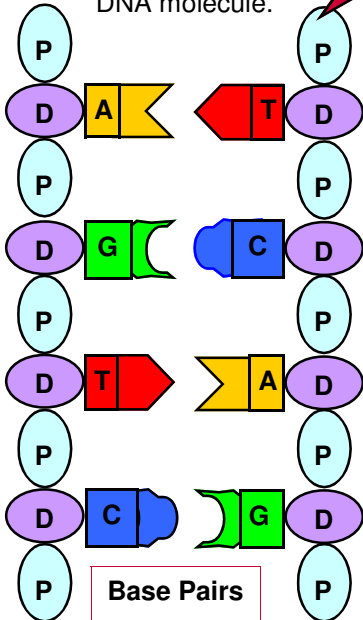

A with **T** and **C** with **G**. The unique pairing of only **A** with **T** and **C** with **G** enables the DNA to make a copy of itself when the two halves of the DNA are separated. It is the nucleotides that carry the instructions to build the living cell. The arrangement is in the form of a ladder and the ladder is coiled into a **double helix shape**.



This shows the Geometrical Symmetry of Position combined with the values **13, 26**

300	296	192	320
300	160	236	376
296	256	320	288
256	192	224	252

$$300 + 300 + 296 + 256 + 320 + 288 + 224 + 252 = 2236$$

300	296	192	320
300	160	236	376
296	256	320	288
256	192	224	252

$$296 + 160 + 256 + 192 + 192 + 320 + 236 + 376 = 2028$$

The yellow block is rotated 90° anticlockwise. The purple block is shifted right one column.

300	296	192	320
300	160	236	376
296	256	320	288
256	192	224	252

$$192 + 236 + 320 + 224 + 300 + 296 + 300 + 160 = 2028$$

Same value as above

300	296	192	320
300	160	236	376
296	256	320	288
256	192	224	252

$$320 + 376 + 288 + 252 + 296 + 256 + 256 + 192 = 2236$$

Same value as above

2236 = 13 x 172 13 is a main factor of **John 1.1**
 2236 = 26 x 86 26 is the value of the Divine Name **The LORD יהוה**
 86 is the value of God **Elohim אלהים** See Page 19
 This **26_86** spell's out the term " **LORD GOD** "
 2236 = 2 x 1118 1118 = 13 x 86 The value of the "Shema" "One GOD"

2028 = 12 x 13 x 13 13 is a main factor of **John 1.1**
 2028 = 3 x 26 x 26 26 is the value of the Divine Name **The LORD יהוה**
 2028 = 2 x 26 x 39 39 = 3 x 13 is the other main factor of **John 1.1**

Let us create the **Proton** count table again but we will **NOW** include the exceptions **ATA, ATG, TGA TGG**. The value **144** gives the new value **296** and the value **128** gives **236**. The next analysis will give us the Biblical numbers, **13** from **John 1.1**, and **26** the **Divine name** from **Deut 6.4**.

The **Count of Protons** in the encoding of the Amino Acids

	A		G		T		C		
A	AAT Asn	70	GAT Asp	70	TAT Tyr	96	CAT His	82	318
	AAC Asn	70	GAC Asp	70	TAC Tyr	96	CAC His	82	318
	AAA Lys	80	GAA Glu	78	TAA Stop	0	CAA Gln	78	236
	AAG Lys	80	GAG Glu	78	TAG Stop	0	CAG Gln	78	236
	300		296		192		320		1108
G	AGT Ser	56	GGT Gly	40	TGT Cys	64	CGT Arg	94	254
	AGC Ser	56	GGC Gly	40	TGC Cys	64	CGC Arg	94	254
	AGA Arg	94	GGA Gly	40	TGA Stop	0	CGA Arg	94	228
	AGG Arg	94	GGG Gly	40	TGG Trp	108	CGG Arg	94	336
	300		160		236		376		1072
T	ATT Ile	72	GTT Val	64	TTT Phe	88	CTT Leu	72	296
	ATC Ile	72	GTC Val	64	TTC Phe	88	CTC Leu	72	296
	ATA Ile	72	GTA Val	64	TTA Leu	72	CTA Leu	72	280
	ATG Met	80	GTG Val	64	TTG Leu	72	CTG Leu	72	288
	296		256		320		288		1160
C	ACT Thr	64	GCT Ala	48	TCT Ser	56	CCT Pro	63	231
	ACC Thr	64	GCC Ala	48	TCC Ser	56	CCC Pro	63	231
	ACA Thr	64	GCA Ala	48	TCA Ser	56	CCA Pro	63	231
	ACG Thr	64	GCG Ala	48	TCG Ser	56	CCG Pro	63	231
	256		192		224		252		924
	1152		904		972		1236		4264

300	296	192	320	$4004 \rightarrow 4264$ $= 4 \times 7 \times 11 \times 13$ $= 7 \times 22 \times 26$	300	296	192	320
300	160	128	376		300	160	236	376
144	256	320	288		296	256	320	288
256	192	224	252		256	192	224	252

The Values in the Matrix change as we include the Rebel group

How is the information i.e. the instructions, conveyed on this double helix ladder. ? The instructions are encoded in the sequence of bases A,G,C,T.

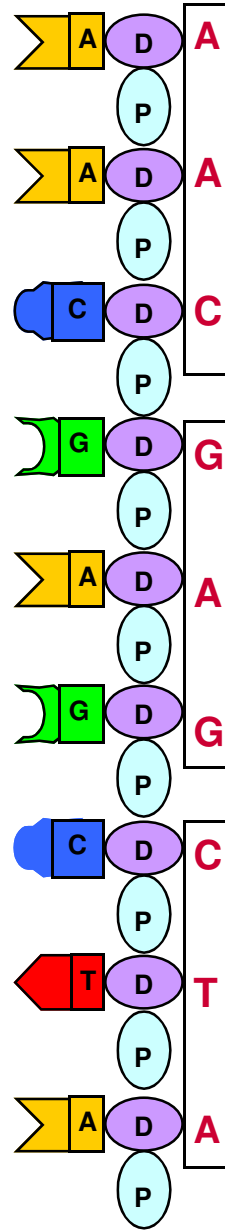

The bases are arranged in groups of 3 letters called a codon. There are 64 possible permutations of 4 bases in groups of 3 letters. The instructions to make 20 amino acids are contained in 3 letter coding system. You could envision, that the 3 different groups of letters, form individual words and the groups of words, form genetic sentences called genes.

There are **3 billion base pairs** in the human genome. Examples of codon codes are

AAC TGT CTA AAA GTC
 Asparagine Cysteine Leucine Lysine Valine
 These are 20 Amino acids and their abbreviations.

Alanine	[Ala]	Leucine	[Leu]
Arginine	[Arg]	Lysine	[Lys]
Asparagine	[Asn]	Methionine	[Met]
Aspartic Acid	[Asp]	Phenylalanine	[Phe]
Cysteine	[Cys]	Proline	[Pro]
Glutamic Acid	[Glu]	Serine	[Ser]
Glutamine	[Gln]	Threonine	[Thr]
Glycine	[Gly]	Tryptophan	[Trp]
Histidine	[His]	Tyrosine	[Tyr]
Isoleucine	[Ile]	Valine	[Val]

The atomic structure of each amino acid is made up of 2 parts, **The Standard Block** and **the Side Chain**. It is **the Side Chain** called the **Radical [R]** that makes the **Standard Block** into the individual Amino Acid.

Side Chain [R] + NH₂CHCOOH Standard Block [B]

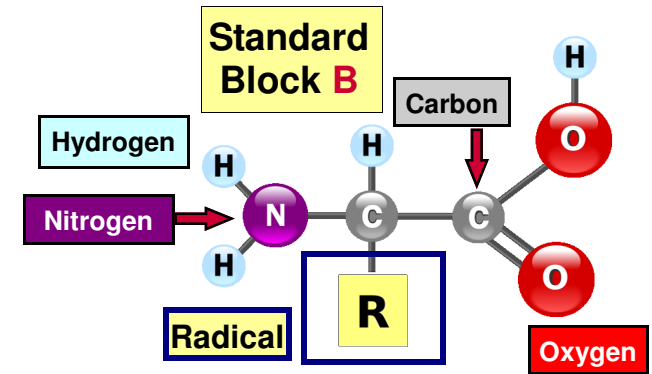

The following table is all the permutations of the 3 lettered Codons and the name of the Amino Acid it codes for. For any DNA sequence, the **START** Codon is **ATG** Methionine and the **STOP** Codons are **TAA, TAG, TGA**.

The **3 letter Codes** from the **64 possible** arrangements exceeds **20 amino acids**. Therefore more than one code generates the same Amino acid. **The duplicates are called its Redundancy.**

	A	G	T	C
A	AAT Asn AAC Asn AAA Lys AAG Lys	GAT Asp GAC Asp GAA Glu GAG Glu	TAT Tyr TAC Tyr TAA Stop TAG Stop	CAT His CAC His CAA Gln CAG Gln
G	AGT Ser AGC Ser AGA Arg AGG Arg	GGT Gly GGC Gly GGA Gly GGG Gly	TGT Cys TGC Cys TGA Stop TGG Trp	CGT Arg CGC Arg CGA Arg CGG Arg
T	ATT Ile ATC Ile ATA Ile ATG Met	GTT Val GTC Val GTA Val GTG Val	TTT Phe TTC Phe TTA Leu TTG Leu	CTT Leu CTC Leu CTA Leu CTG Leu
C	ACT Thr ACC Thr ACA Thr ACG Thr	GCT Ala GCC Ala GCA Ala GCG Ala	TCT Ser TCC Ser TCA Ser TCG Ser	CCT Pro CCC Pro CCA Pro CCG Pro

	ATG - start code
Methionine	Met
Tryptophan	Trp
Asparagine	Asn
Aspartic Acid	Asp
Cysteine	Cys
Glutamic Acid	Glu
Glutamine	Gln
Histidine	His
Lysine	Lys
Phenylalanine	Phe
Tyrosine	Tyr
Isoleucine	Ile
Alanine	Ala
Glycine	Gly
Proline	Pro
Threonine	Thr
Valine	Val
Arginine	Arg
Leucine	Leu
Serine	Ser

Incomprehensible Irrationality
It is **IRRATIONAL to believe**, that **DNA**, the Sophisticated Incredibly Ingenious, Irreducibly Complex, Ultra-Miniaturised, Brilliantly designed Encoding with **Signatures** is the result of **Undirected Random Forces**.

300	296	192	320
300	160	128	376
144	256	320	288
256	192	224	252

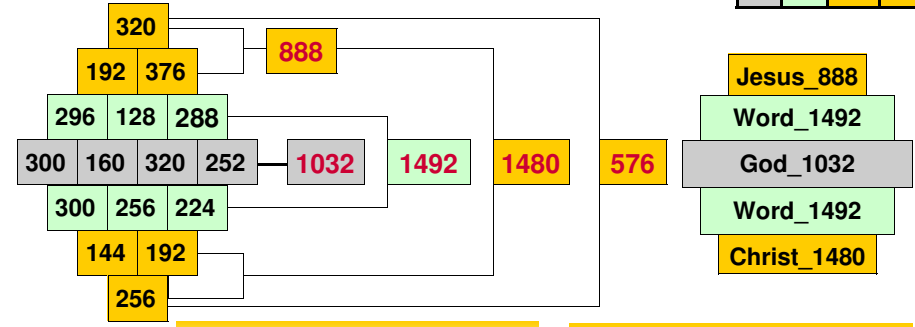

$320 + 192 + 376 = 888$
** Ιησους 'Jesus' = 888

$296 + 128 + 288 + 300 + 256 + 224 = 1492$
 $1492 = 4 \times 373$ 'λογος' = 'Word' = 373
1492 is the Hebrew Value Isa 9.6

"Wonderful Counselor, Mighty God, Everlasting Father, Prince of Peace"

$320 + 192 + 376 = 888$
 $144 + 192 + 256 = 592$
 $888 + 592 = 1480$
Χριστος 'Christ' = 1480
'Jesus Christ' = 1480
'Word' is the Title of Jesus Christ

'Jesus' = 888 = 3 x 8 x 37
'Christ' = 1480 = 5 x 8 x 37
 $320 + 256 = 576 = 8 \times 8 \times 3 \times 3$
And 3 is the sign of Deity 3 in 1

$300 + 160 + 320 + 252 = 1032$
 $1032 = 12 \times 86$
אלהים 'Elohim' = 'God' = 86

This Symmetry of Protons gives an astounding result about the Deity. Also the count of the number of atoms in the 64 triplets of all the amino acids is 1147 = 31 (John 1.1) x 37 (Gen 1.1). These are the two key factors of the main scriptures about the origin of life on this Earth.

The encoding of Jesus Christ, the Word and God on this matrix truly stamps the Protons as having God as their Author

"the kingdom of his dear Son: In whom we have redemption through his blood, even the forgiveness of sins: Who is the image of the invisible God, the firstborn of every creature:

For by him were all things created, that are in heaven, and that are in earth, visible and invisible, whether they be thrones, or dominions, or principalities, or powers: all things were created by him, and for him: And he is before all things, and by him all things consist." Col 1:13-17

The Geometry of Symmetry of Position and Numerical values

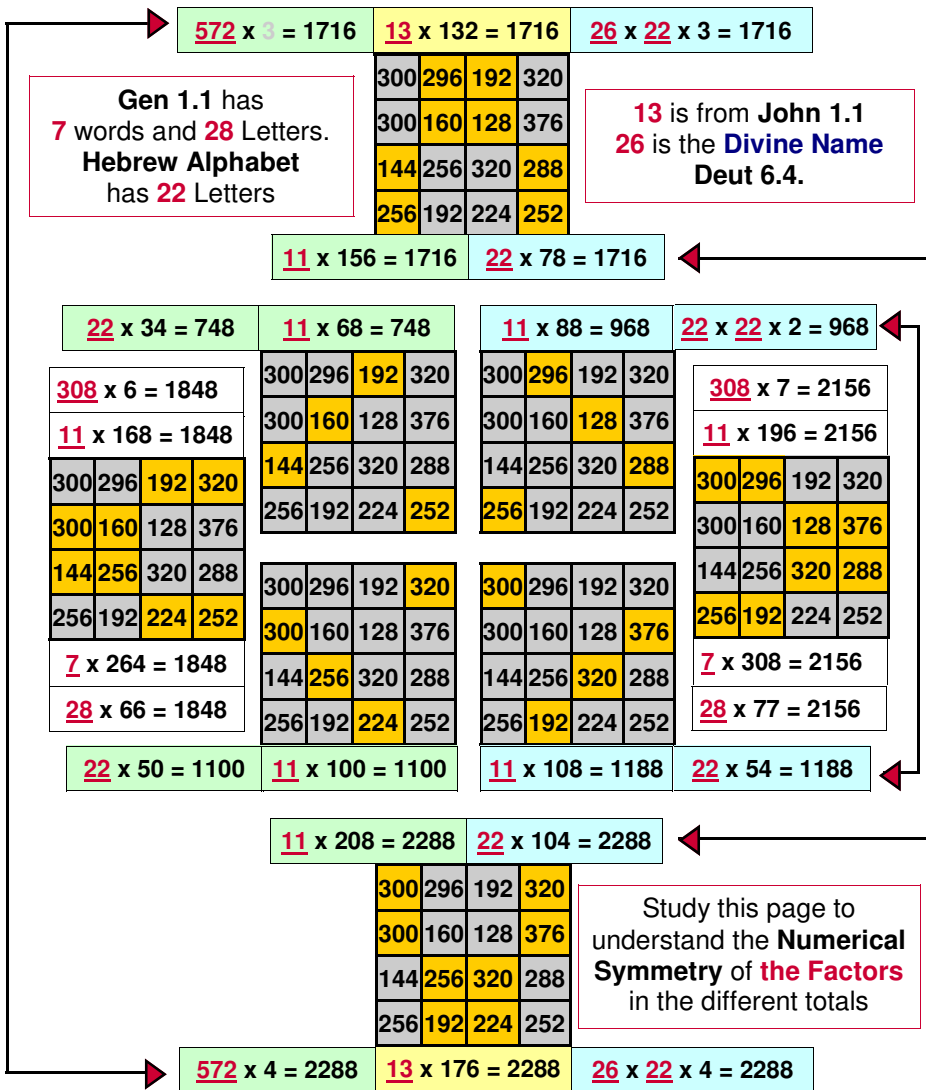

The whole diagram has both **line Symmetry** and **Rotational Symmetry**.

The total of the matrix is $4004 = 2 \times 7 \times 13 \times 22 = 2 \times 7 \times 11 \times 26$

The figure exhibits all the factors of **7, 11, 13, 22** and **26** in an most elegant Symmetry. The **larger the Factor** the more **impressive the symmetry!**

The Creator at work in the DNA codes. No Evolution! No Natural Selection!

Alanine_ALA_A

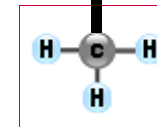
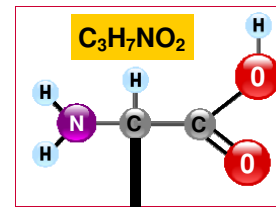

Ala	R	B	89.0935
Proton	9	39	48
Neutron	6	35	41
Total	15	74	89

Arginine_ARG_R

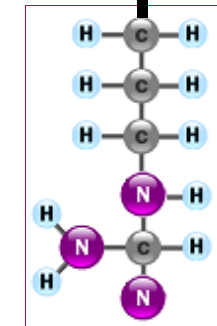
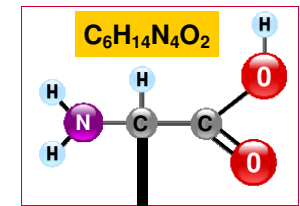

Arg	R	B	174.2017
Proton	55	39	94
Neutron	45	35	80
Total	100	74	174

Asparagine_ASN_N

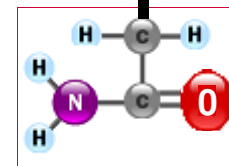
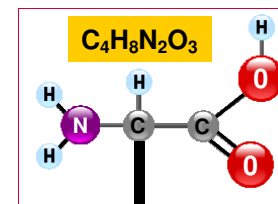

Asn	R	B	132.1184
Proton	31	39	70
Neutron	27	35	62
Total	58	74	132

Standard Block B

Standard Block B

Key

Element		Neutron	Proton
Carbon	${}_6\text{C}^6$	6	6
Hydrogen	${}_1\text{H}^1$	—	1
Nitrogen	${}_7\text{N}^7$	7	7
Oxygen	${}_8\text{O}^8$	8	8
Sulphur	${}_{16}\text{S}^{16}$	16	16

Aspartic Acid **ASP_A**

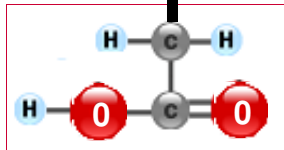
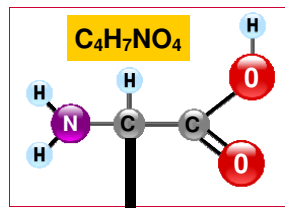

Asp	R	B	133.1032
Proton	31	39	70
Neutron	28	35	63
Total	59	74	133

Cysteine **CYS_C**

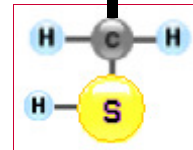
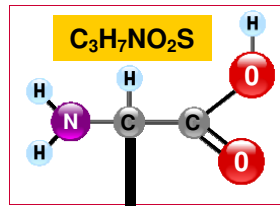

Cys	R	B	121.1590
Proton	25	39	64
Neutron	22	35	57
Total	47	74	121

Standard Block **B**

Glutamic acid **GLU_E**

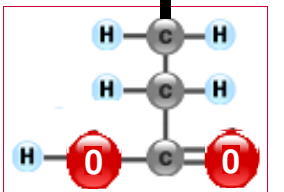
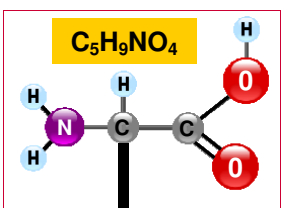

Glu	R	B	147.1299
Proton	39	39	78
Neutron	34	35	69
Total	73	74	147

Glutamine **GLN_Q**

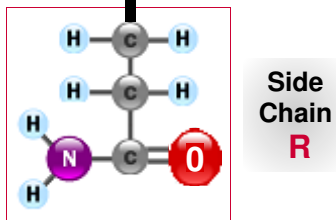
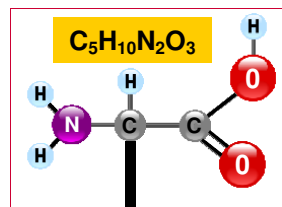

Gln	R	B	146.1451
Proton	39	39	78
Neutron	33	35	68
Total	72	74	146

Standard Block **B**

The Total number of **Protons** in the table is

$$4004 = 4 \times 7 \times 11 \times 13 = 7 \times 22 \times 26 = 28 \times 11 \times 13$$

We know from our studies that **7, 11 and 13** are **Biblical Numbers** that have great prominence. **7 days of the week, 70 weeks of Daniel, the 7 last plagues** etc. **13** and its reflection **31** is the number encoded in the **Gen 1.1, "Shema" Deut 6.4, and John 1.1 7 + 11 + 13 = 31**

Also the **Symmetry** that you will see shows that everything is numbered in such a way to **exclude Randomness** from **the Creation of life**.

A pair of single elements. (1)	300	296	192	320	$3528 = 7 \times 504 = 28 \times 126$ $252 = 7 \times 36 = 28 \times 9$ $224 = 7 \times 32 = 28 \times 8$
	300	160	128	376	
	144	256	320	288	
	256	192	224	252	
A pair of two elements. (2)	300	296	192	320	$3080 = 7 \times 440 = 28 \times 110$ $448 = 7 \times 64 = 28 \times 16$ $476 = 7 \times 68 = 28 \times 17$
	300	160	128	376	
	144	256	320	288	
	256	192	224	252	
A pair of four elements. (4)	300	296	192	320	$2072 = 7 \times 296 = 28 \times 74$ $1008 = 7 \times 144 = 28 \times 36$ $924 = 7 \times 132 = 28 \times 33$
	300	160	128	376	
	144	256	320	288	
	256	192	224	252	
A pair of eight elements. (8)	300	296	192	320	$2072 = 7 \times 296 = 28 \times 74$ $1932 = 7 \times 276 = 28 \times 69$
	300	160	128	376	
	144	256	320	288	
	256	192	224	252	
Sixteen elements. (16)	300	296	192	320	$4004 = 7 \times 572 = 28 \times 143$ The sum of all the digits $3+3+1+4+...+2+5+2 = 161 = 7 \times 23$
	300	160	128	376	
	144	256	320	288	
	256	192	224	252	

These two factors **7, 28** are encoded in **Gen 1.1, 7 words and 28 letters**.

Inspecting the table of **Amino Acids** it is apparent that any codon ending in **T & C** or **A & G** will code for **the Same Amino Acid except** (BOULAY calls these codons the rebel group) the codons **ATA, ATG, TGA and TGG** marked in light Blue. These codons are **exceptions** to the above rule so they are **not** included in the **Proton Count**.

The **Count of Protons** in the encoding of the **Amino Acids**

	A		G		T		C	
A	AAT Asn	70	GAT Asp	70	TAT Tyr	96	CAT His	82
	AAC Asn	70	GAC Asp	70	TAC Tyr	96	CAC His	82
	AAA Lys	80	GAA Glu	78	TAA Stop	0	CAA Gln	78
	AAG Lys	80	GAG Glu	78	TAG Stop	0	CAG Gln	78
	300		296		192		320	1108
G	AGT Ser	56	GGT Gly	40	TGT Cys	64	CGT Arg	94
	AGC Ser	56	GGC Gly	40	TGC Cys	64	CGC Arg	94
	AGA Arg	94	GGA Gly	40	TGA Stop	0	CGA Arg	94
	AGG Arg	94	GGG Gly	40	TGG Trp	108	CGG Arg	94
	300		160		128		376	964
T	ATT Ile	72	GTT Val	64	TTT Phe	88	CTT Leu	72
	ATC Ile	72	GTC Val	64	TTC Phe	88	CTC Leu	72
	ATA Ile	72	GTA Val	64	TTA Leu	72	CTA Leu	72
	ATG Met	80	GTG Val	64	TTG Leu	72	CTG Leu	72
	144		256		320		288	1008
C	ACT Thr	64	GCT Ala	48	TCT Ser	56	CCT Pro	63
	ACC Thr	64	GCC Ala	48	TCC Ser	56	CCC Pro	63
	ACA Thr	64	GCA Ala	48	TCA Ser	56	CCA Pro	63
	ACG Thr	64	GCG Ala	48	TCG Ser	56	CCG Pro	63
	256		192		224		252	924
	1000		904		864		1236	4004

I am indebted to the work of **Jean-Yves BOULAY** for his researches. All this information is found on the Internet. His proline Hypothesis makes the Proline protons equal to 39 to bring it in line with the rest of the Amino acids. So that the total protons are $24 + 39 = 63$ [was 62 on page 12]. Do a Google search using Boulay hypothesis proline

300	296	192	320
300	160	128	376
144	256	320	288
256	192	224	252

Glycine_GLY_G

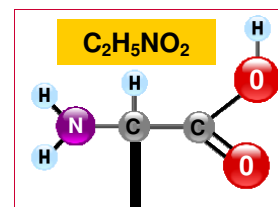

Side Chain
R

Gly	R	B	75.0669
Proton	1	39	40
Neutron	0	35	35
Total	1	74	75

Isoleucine_ILE_I

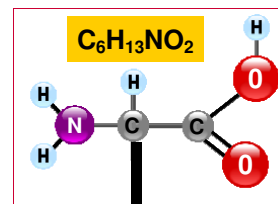

Side Chain
R

Ile	R	B	131.1736
Proton	33	39	72
Neutron	24	35	59
Total	57	74	131

Standard Block **B**

Standard Block **B**

Histidine_HIS_H

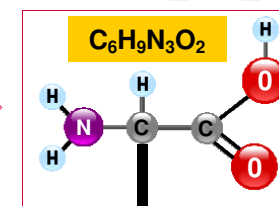

Side Chain
R

His	R	B	155.1552
Proton	43	39	82
Neutron	38	35	73
Total	81	74	155

Standard Block **B**

Leucine_LEU_L

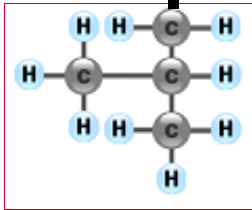
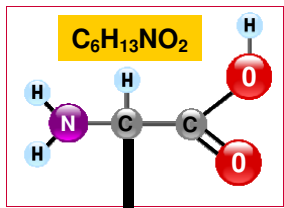

Side Chain R

Leu	R	B	131.1736
Proton	33	39	72
Neutron	24	35	59
Total	57	74	131

Lysine_LYS_K

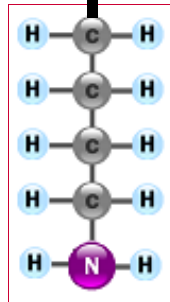
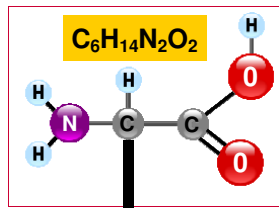

Side Chain R

Lys	R	B	146.1882
Proton	41	39	80
Neutron	31	35	66
Total	72	74	146

Methionine_MET_M

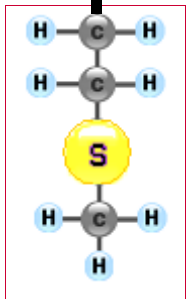
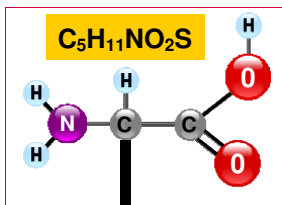

Side Chain R

Met	R	B	149.2124
Proton	41	39	80
Neutron	34	35	69
Total	75	74	149

On the left page we have taken the **codons** with **two identical letters**, we can take the rest—the complement, of the **64 codons**.

This fifth Symmetry of **shCherbak** (Rumer) is based on selecting those **codons** that have **3 Identical bases**

TTT, CCC, AAA, GGG

plus those with **3 different bases**

e.g. **ATC, TCA, CAT** etc

thus completing the whole table of **Amino Acids**.

When the **3 bases** are different, the **Bases** can be taken in a **Cyclic Clockwise** or **Anti-Clockwise** sequence thus producing the different **Amino Acids**.

First Signature to notice is the numerical values equal split. The radical and Standard block have equal counts of Nucleons between the Clockwise and Anti-clockwise rotations. That was a surprise. But not only that, the **Signature of 37** is encoded in both. Now a reminder.

The value of **703 = 19 x 37** Signature **37** and is the **19th triangular**

‘הָאָרֶץ’ **Earth the** וְאֵת **and** 296 (90,200,1,5) + 407 (400,1,6) = 703
 יְהוָה **the Divine Name**, the tetragrammaton ‘LORD the’ (5,6,5,10) = 26

number. This **703** is the value of the words from **Gen 1.1** “and the Earth”. **DNA** is created here on **Earth**.

Also **703** is the value of the **centre insert** in the triangulation of **Gen 1.1** **2701 = 37 x 73**. The other value **962 = 26 x 37 = 2 x 13 x 37**

Now **703** its neighbour **702 = 3³ x 26** and **26** is the **Divine Name Deut 6.4**.

Also **962** its neighbour **961 = 31 x 31 (Proline)**. Remember **John 1.1** has the **two Signatures 13** and its reflection **31** all encoded in this values.

John 1.1 = 3 x 13 x 31 x 3. Hebrew for God I) = 31 in Isa 9.6

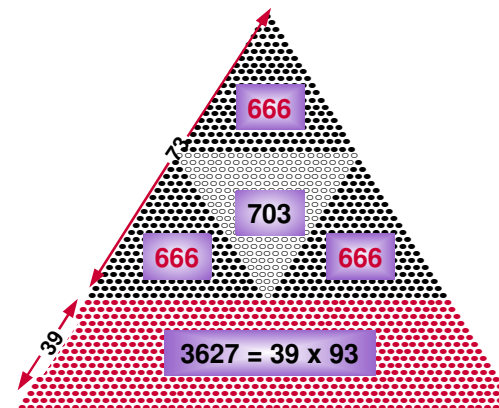

Also **961 = ‘And his name shall be called.. Mighty.. Father.. Everlasting’**

These **Signatures** in **DNA** are plain for all to see and are just as plain to see in the **Scriptures**. **DNA** does not tell us ‘**who it was**’ therefore these scientists use the term ‘**what ever it was**’ yet the **Bible** tells us, **His identity** is ‘**God**’ ‘**Elohim**’

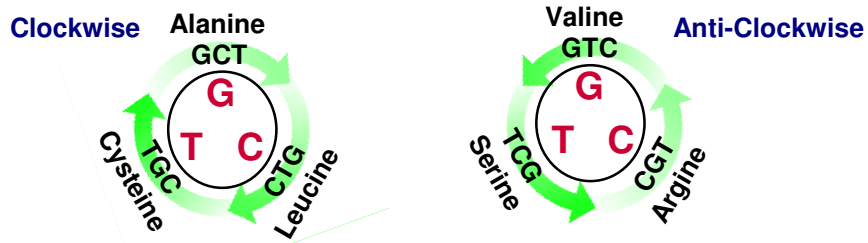

	R	B		R	B	
Phe	91	74	T T T	G G G	1	74
Lys	72	74	A A A	C C C	41	74
						Gly
						Pro

Clockwise Anti Clockwise

Reflections

Ile	57	74	A T C	C A T	57	74	Leu
Ser	31	74	T C A	A C T	45	74	Thr
His	81	74	C A T	T A C	107	74	Tyr
Ala	15	74	G C T	T C G	31	74	Ser
Leu	57	74	C T G	G T C	43	74	Val
Cys	47	74	T G C	C G T	100	74	Arg
Stop	0	0	T G A	A G T	31	74	Ser
Asp	59	74	G A T	T A G	0	0	Stop
Met	75	74	A T G	G T A	43	74	Val
Gln	72	74	C A G	G A C	59	74	Asp
Ser	31	74	A G C	C G A	100	74	Arg
Ala	15	74	G C A	A C G	45	74	Thr

703 = 19 x 37
962 = 26 x 37

703 + 962 703 + 962

Proline with no activation key. Nucleons 961

Gen 1.1 703 = 19 x 37 Value of 'and the Earth'

Isa 9.6 962 = 26 x 37 Value of 'his name, Wonderful Counsellor, Mighty God, Everlasting Father'

Phenylalanine_PHE_F

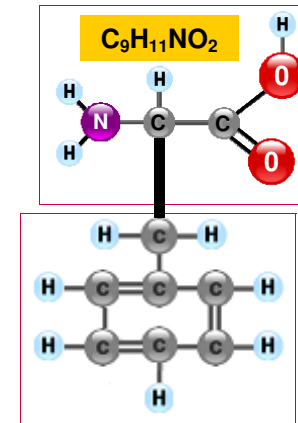

Phe	R	B	165.1900
Proton	49	39	88
Neutron	42	35	77
Total	91	74	165

Proline_PRO_P

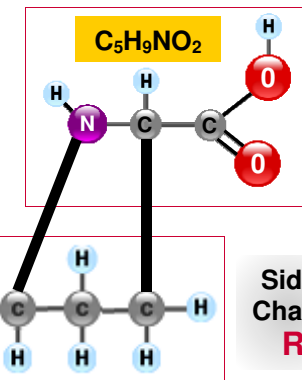

Pro	R	B	115.1310
Proton	24	38	62
Neutron	18	35	53
Total	42	73	115

Serine_SER_S

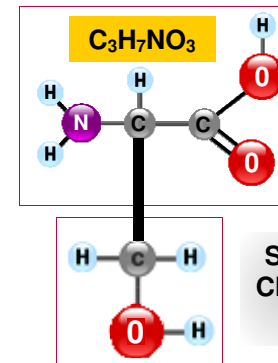

Ser	R	B	105.0930
Proton	17	39	56
Neutron	14	35	49
Total	31	74	105

Threonine_THR_T

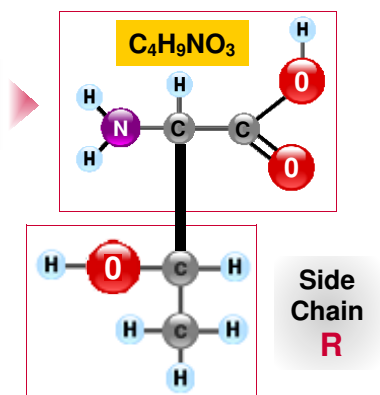

Thr	R	B	119.1197
Proton	25	39	64
Neutron	20	35	55
Total	45	74	119

Tryptophan_TRP_W

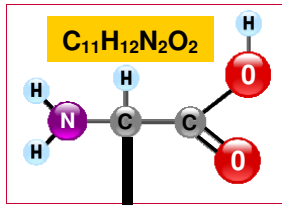

Standard Block B

Standard Block B

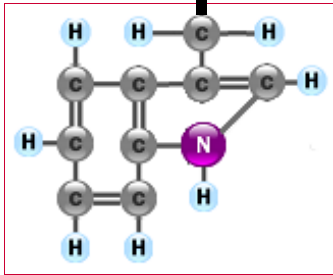

Side Chain R

Trp	R	B	204.2262
Proton	69	39	108
Neutron	61	35	96
Total	130	74	204

Tyrosine_TYR_Y

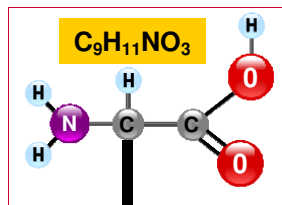

Standard Block B

Standard Block B

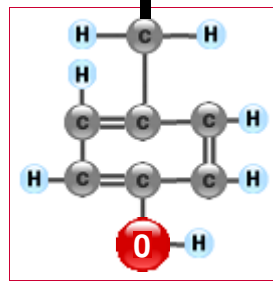

Side Chain R

Tyr	R	B	181.1894
Proton	57	39	96
Neutron	50	35	85
Total	107	74	181

Valine_VAL_V

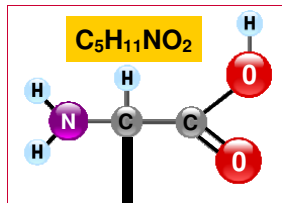

Standard Block B

Standard Block B

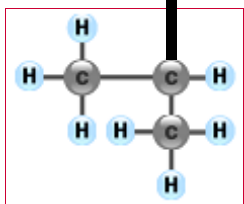

Side Chain R

Val	R	B	117.1469
Proton	25	39	64
Neutron	18	35	53
Total	43	74	117

Analysis of the Final Totals of Purines and Pyrimidines

Type	R	B	Total
A	535	592	1127
G	464	666	1130
Total	999	1258	2257
T	547	666	1213
C	452	666	1118
Total	999	1332	2331

$999 = 3^3 \times 37$
'In the beginning God created the Heavens'
 Gen 1.1

$666 = 2 \times 3^2 \times 37$
 Part of the Triangulation of Gen 1.1
'and the Word was God'
 John 1.1



$1258 = 2 \times 17 \times 37$

Final Totals

$1118 = 13 \times 86$
 'Shema'
 'One (13) God (86)'
 Deut 6.4, John 1.1 Neighbourhood
 $1119 = 3 \times 373$

Type	R	B	Totals
A & G	999	1258	2257
T & C	999	1332	2331
Total	1998	2590	4588

$2257 = 61 \times 37$

$2331 = 3 \times 3 \times 7 \times 37$

$1998 = 2 \times 3^3 \times 37$
'In the beginning God created the Heavens'

$4588 = 4 \times 31 \times 37$
 31 is the main Signature John 1.1
 37 is the main Signature Gen 1.1

The Prolific Signature of 37 in the DNA which is mapped onto the Scriptures of Gen 1.1, John 1.1, Isaiah 9.6 & 53.5, By the Names of Our Lord and Saviour 'Jesus' 'Christ' and His Creative name the 'Word'

$2590 = 10 \times 7 \times 37$

$1332 = 4 \times 3^2 \times 37$



'Jesus' = 24×37 'Christ' = 40×37
 'Word' = $373 = (37)3 = 3(73)$
 $373 = 74^{\text{th}}$ Prime Number
 $74 = 73 + 1, 74 = 2 \times 37$

Select Amino Acids with two identical Bases and arrange between the Purines and the Pyrimidines.

Purines 2 Identical Bases. shCherbak's--4th Symmetry Pyrimidines 2 Identical Bases.

T A A	C A A	G A A	T G G	C G G	A G G	A T T	G T T	T C C	A C C	G C C
A A T T A A A T A	A A C C A A A C A	A A G G A A A G A	G G T T G G G T G	G G C C G G G C G	G G A A G G G A G	T T A A T T T A T	T T G G T T T G T	C C T T C C C A C	C C A A C C C A C	C C G G C C C G C
Asn 58~74	Asn 58~74	Lys 72~74	Gly 1~74	Gly 1~74	Gly 1~74	Lue 57~74	Lue 57~74	Pro 41~74	Pro 41~74	Pro 41~74
Stop 0 ~ 0	Gln 72~74	Glu 73~74	Trp 130~74	Arg 100~74	Arg 100~74	Ile 57~74	Val 43~74	Ser 31~74	Thr 45~74	Ala 15~74
Ile 57~74	Thr 45~74	Arg 100~74	Val 43~74	Ala 15~74	Glu 73~74	Tyr 107~74	Cys 47~74	Lue 57~74	His 81~74	Arg 100~74
R B 115~148	R B 175~222	R B 245~222	R B 174~222	R B 116~222	R B 174~222	R B 221~222	R B 147~222	R B 129~222	R B 167~222	R B 156~22
$115+175+245 = 535$	$148+222+222 = 592$	$174+116+174 = 464$	$222+222+222 = 666$	$222+222+222 = 666$	$179+221+147 = 547$	$179+221+147 = 547$	$222+222+222 = 666$	$129+167+156 = 452$	$222+222+222 = 666$	$222+222+222 = 666$
R 535	B 592	R 464	B 666	B 666	R 547	R 547	B 666	R 452	B 666	B 666

Total Nucleons Radical St. Block

Side Chains **A** 535 + 592 = 1127
 balanced **G** 464 + 666 = 1130
 (999) 999 + 1258 = 2257

Total Nucleons Radical St. Block

Side Chains **T** 547 + 666 = 1213
 balanced **C** 452 + 666 = 1118
 (999) 999 + 1332 = 2331

Ala Proton 9 Neutron 6 Total 15	B 39	Glu Proton 39 Neutron 34 Total 73	R 39	Leu Proton 33 Neutron 24 Total 57	B 131	Ser Proton 17 Neutron 14 Total 31	R 39	105.0930 56 49 105
Arg Proton 55 Neutron 45 Total 100	B 39	Gln Proton 39 Neutron 33 Total 72	R 39	Lys Proton 41 Neutron 31 Total 72	B 146	Thr Proton 25 Neutron 20 Total 45	R 39	119.1197 64 55 119
Asn Proton 31 Neutron 27 Total 58	B 39	Gly Proton 1 Neutron 0 Total 1	R 39	Met Proton 41 Neutron 34 Total 75	B 149	Trp Proton 69 Neutron 61 Total 130	R 39	204.2262 108 96 204
Asp Proton 31 Neutron 28 Total 59	B 39	His Proton 43 Neutron 38 Total 81	R 39	Phe Proton 49 Neutron 42 Total 91	B 165	Tyr Proton 57 Neutron 50 Total 107	R 39	181.1894 96 85 181
Cys Proton 25 Neutron 22 Total 47	B 39	Ile Proton 33 Neutron 24 Total 57	R 39	Pro Proton 24 Neutron 18 Total 42	B 115	Val Proton 25 Neutron 18 Total 43	R 39	117.1469 64 53 117
Total 47	74	Total 121	74	Total 131	74	Total 115	74	Total 43

The study examines Amino Acids by Arithmetic with Prime Numbers. The Amino Acids encoded numerically, achieved by counting the Protons and Neutrons of each Amino Acid. The Count, split between the Standard Block [B] and the Radical [R]. The above table gives all the relevant data. Highlighted are the Prime Factors 37, 73 [Gen 1.1] and 3, 13 (39), 31 [John 1.1], the Same Signature as the Genetic Code.

The Symmetry Table of the Signature of the Prime 37

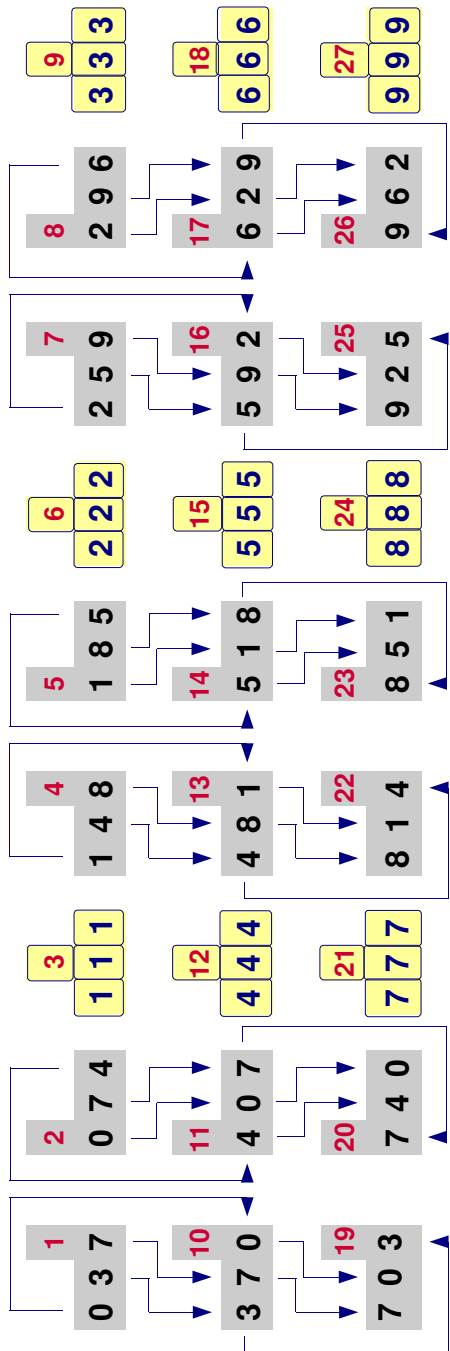

Multiplication Table for 37

$3+7+0=10$ $4+0+7=11$ $4+4+4=12$ $4+8+1=13$ $5+1+8=14$ $5+5+5=15$ $5+9+2=16$ $6+2+9=17$ $6+6+6=18$

The decimal value 37 carries a digital symmetry that is truly unique as illustrated above. Note the columns with the yellow 3 digits identical. The sum of those with identical digits give the quotient when the value is divided by 37, i.e. $555 / 37 = 15 = 5+5+5$. This is also repeated along the centre row i.e. $481 / 37 = 13 = 4+8+1$.

In each column the values divided 37 give cyclic rotations of the same digits i.e. 148, 481, 814 etc. Take the sum ANY set of 3 digit values, then obtain the factors of this sum. If the factors turn out to be either $3, 3^2, 3^3, 37$ or all of them, then if we further concatenated these same 3 digit values to form a new value, then this new value will always have the same factors of $3, 3^2, 3^3, 37$ or all of them. This because $3^3 \times 37 = 999$.

Example $913 + 203 + 086 + 401 + 395 = 1998 = 2 \times 3^3 \times 37$.

Now Concatenate $913203086401395 = 3 \times 3^3 \times 5 \times 37 \times 70949 \times 858943$

Also when the digits are cyclically rotated, then the factors of the rotated values will still contain 3^3 and 37.

So far from our study what have we learnt ? We have come to understand the structure of DNA and how it is turned into a numerical structure by some Scientists who are Evolutionists and NOT Creationists.

What have they discovered. They have uncovered a Numerical Structure encoded in the Protons and Neutrons in the Atomic structure of the 20 Amino Acids.

They have found it is all based on the number 37. Why is this unusual ?

37 has very special properties that NO other numbers possess which we have shown previously and it can be proved by Algebra. The Scientists have discovered the Decimal System is embedded and the invention of Zero. This encoding has supposedly occurred Billions of years ago.

Now the Design in the Numerical arrangement of DNA could NOT have evolved under Natural Selection, so the Scientists have to infer that the source of this construction which is artificial (i.e. cannot happen by itself) must be of an intelligent origin. They call this source 'What ever it was'.

If you read their papers on this# you can see clearly that they are factual because the 20 Amino Acids are fixed and their molecular structure is fixed and the Mathematical analysis is rigorous. So they have proved that 37 is the KEY and its reflection 73.

We Creationists have researched the Hebrew and Greek of the Biblical texts and have shown that the encoding in the words and letters are Exactly the Same Structure with 37 and 73 emerging as the KEY.

Their analysis does not say WHO was this intelligent source (billions of years ago) but in the case of the Biblical Analysis, it IDENTIFIES to us, EXACTLY WHO it WAS and IS, namely our God and Saviour Jesus (37) Christ (37), the WORD (373) and Gen 1.1 (37 x 73).

Our investigation is completely based on evidence because the Hebrew is fixed, the Greek is fixed and the Mathematical Analysis is rigorous.

You have to be as blind as a bat not to see the logic.

Invincible prejudice against anything to do with God blinds their reasoning processes so the Atheists are without excuse.

I cannot say those Scientists who cannot see the evidential link are not very bright, because they are highly intelligent well educated people so if they reject the link it must something deep inside their mental processes that perhaps they themselves are not aware of, which stops faith, based on evidence, from germinating.

Now to continue with our Study. I know it is difficult but keep reading.

Obtainable from peter bluer peter@biblemaths.com

Proline is the **Only Amino Acid** that encodes **the Signature of 73**.

Gen 1.1 37 x 73. The 73rd Triangular Number.

The Total value of the **64 Codons** is **3145**

The centre has **813** Nucleons then the outside border has **2332** Nucleons.

$$3145 = 85 \times 37 \quad \text{The Signature of 37}$$

$$813 = 22 \times 37 (814) - 1$$

$$2332 = 63 \times 37 (2331) + 1$$

Now what is the significance of **2332**. We have that

$$2332 = 11 \times 2^2 \times 53$$

And **2331 = 3 x 3 x 7 x 37** neighbour of **2332**.

Apart from the fact that **37** appears again we have the interesting **Signature 2² x 53**.

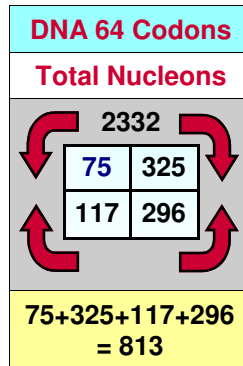
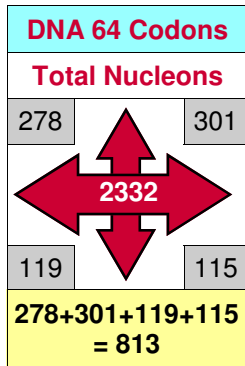

2² x 53 (212) is the value of **SIN** in the Prophecy of **Daniel's 70 weeks** that prophesies the coming of **Jesus Christ the Messiah**

and **His Death as a Sacrifice** for **SIN**.*

Also **37 & 53** appear in the **Biblical Egyptian Triangle (37⁰ + 53⁰ = 90⁰)[#]**

296 = 'and the Earth' Gen 1.1

$$296 \times 3^2 + 296 \times 4^2 = 296 \times 5^2$$

$$888^2 + 1184^2 = 1480^2$$

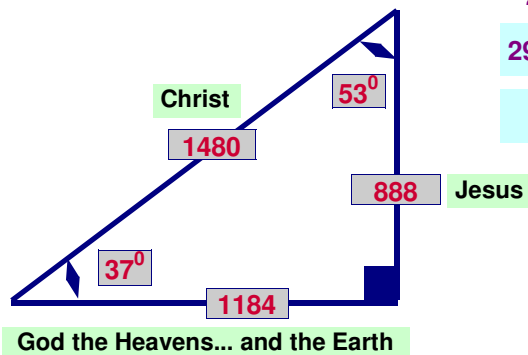

This Symmetry displayed in the **inner and outer Amino Acids** and it is hard to believe if all this is a product of **Random forces**. **To invoke Random forces is nonsense!** As I have repeatedly said, this is the work of **Our Creator and Saviour from Sin and Death, Jesus Christ**.

* See Book '**373 A Proof Set in Stone**' # Booklet '**Seven Unusual Numbers**'

The purpose of the next three pages is to introduce you to **a subject totally unknown virtually by everyone**. It will involve patience and a degree of perseverance as **the subject** is somewhat difficult. It will show that **the Signature** discovered in **DNA** only quite recently by Scientists as revealed by the Number **37** and its reflection **73**.

The **product** of **37 x 73** with their decimal reflection Digits gives **2701**.

This value of **2701** is **a triangular number** as illustrated below. The full triangle above is made up of **2701 counters**. What is **special** is that this triangle is **Unique**. If you require **two reflective decimal digits XY & YX** that produce **a triangle number** (structure) as above such that one of the factors **YX** gives the sides of **the equilateral triangle** length **YX** then you can prove by **Algebra** that the **only possible** values are **37** and **73**.

The **rigorous proof** is in my booklet a '**Challenge to Atheists**'.

Notice too that the triangular number **703** side length **37**, fits precisely in the centre of this **Elegant Structure**. It has **special properties** as the Triangle shown below. Not only are they **37, 73** triangular numbers but are also **hexagon** and **Hexagram** numbers.

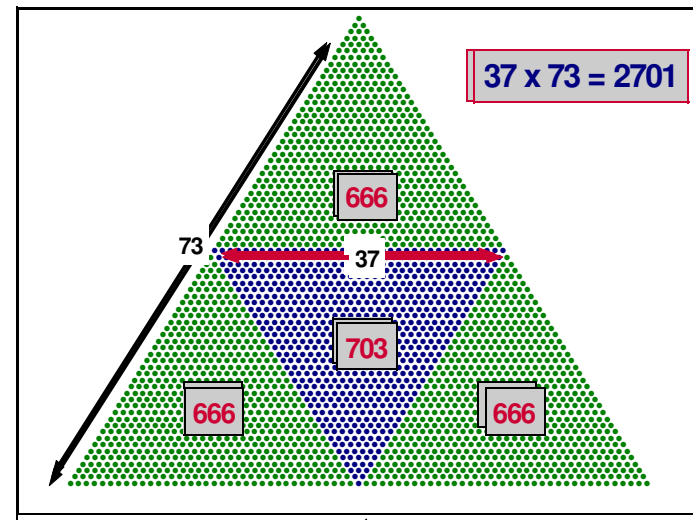

The next few pages will examine the Bible for **13, 31, 39, 37 73** The Signatures.

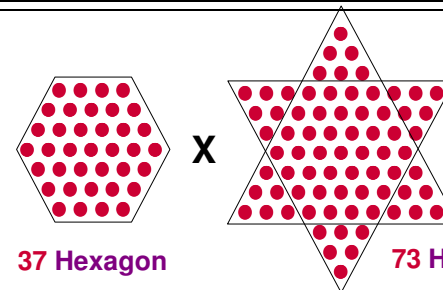

$$37_{10} \times 73_{10} = 37 \times 73 = 2701$$

2701 Triangular Number

To help with the Numerical analysis of DNA, you need to know the Biblical Analysis of Gen 1.1, John 1.1, Deut 6.4. The full explanation of the following is found in my Booklet "Seven Unusual Numbers"

Letter (Shape of letter when written at the end of a word)	א	ב	ג	ד	ה	ו	ז	ח	ט	י	כ	ך
Numeric Value	1	2	3	4	5	6	7	8	9	10	20	

ל	ם	ן	ע	פ	צ	ק	ר	ש	ת	
30	40	50	60	70	80	90	100	200	300	400

We can now apply these values to our 7 words with 28 letters.

Primes	Order No	Word	Value	Calculation
2	1	בראשית ₁	913	400 + 10 + 300 + 1 + 200 + 2
3	2	ברא ₂	203	1 + 200 + 2
5	3	אלהים ₃	86	40 + 10 + 5 + 30 + 1
7	4	את ₄	401	400 + 1
11	5	השמים ₅	395	40 + 10 + 40 + 300 + 5
13	6	ואת ₆	407	400 + 1 + 6
17	7	הארץ ₇	296	90 + 200 + 1 + 5
19	8	Total	913 + 203 + 86 + 401 + 395 + 407 + 296 = 2701	

The value of each word 913, 203... look random, with no particular relationship to each other, but is this True ?
 Let us examine the total value 2701. It turns out that this number 2701 is unique and is a remarkable value.
 2701 is made up of 2 primes 37 & 73, i.e. 37 x 73 = 2701.
 The factors 37, 73 are decimal reflections of each other.
 Now 37 is 12th prime number and 73 is 21st prime number and these order numbers 12 - 21 are also decimal reflections. Next take the decimal reflection of 2701 - 1072 and add these two values together we get the **palindrome**** 3773. Note 37, 73 again. This is not all ! We find the factors of 3773 are 11 x 7 x 7 x 7 or 11 x 7³ (7 & 3 again)

** Palindrome is a number that reads the same, forwards and backwards.

Radical		
Protons	Neutrons	Nucleons

Standard Block		
Nucleons	Neutrons	Protons

Asn	31	27	58		74	35	39
Lys	41	31	72	278	74	35	39
Thr	25	20	45	119	74	35	39
His	43	38	81		74	35	39
Gln	39	33	72	301	74	35	39
Pro	23	18	41	115	74	35	39
	202	167	369	813	444	210	234

Gly	1	0	1	75	74	35	39
Val	25	18	43	117	74	35	39
Cys	25	22	47		74	35	39
Stop	0	0	0		0	0	0
Trp	69	61	130	325	74	35	39
Phe	49	42	91		74	35	39
Leu	33	24	57	296	74	35	39
	202	167	369	813	444	210	234

Inspecting we can see that the sum of the Protons in the Blue Inner Section 202 is exactly the same Proton sum 202 as the Outer Green Section. It is the same Symmetry in the Standard Block Protons between the Blue Inner sum 234 and Green Outer sum 234 sections.

It is an amazing phenomena that the Protons in the Radical and in the Standard Block are distributed at the centre and the outside in equal amounts even though the Amino Acids are completely different.

We have analysed the Neutron count and found the Same Symmetry and because the Protons and Neutrons match under this Symmetry, it follows that the Total Nucleons will also match. Note that this Symmetry applies in the Radical and the Standard Block. Nucleons Inner (444) and Outer (444) sum to 888 (444 + 444) which is the value of the name

'Jesus' in the Greek Language. Jesus = Ἰησους 888 = 24 x 37.

An Additional Symmetry by Peter Bluer

Because the **Columns** interchange with the **Rows** there is another remarkable symmetry that appears. The sum of **Outer Green Corners** have exactly the Same Totals of **Nucleons** as the **Inner Blue Centres**.

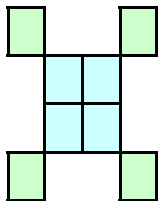

278	132	Asn	+	155	His	301
	146	Asn			His	
75		Lys	+	121	Gln	325
		Lys			Gln	
117		Gly	+	0	Cys	296
		Gly			Cys	
		Gly			Stop	
		Gly			Trp	
119		Val	+	165	Phe	115
		Val			Phe	
		Val			Leu	
		Val			Leu	
		Thr			Pro	
		Thr			Pro	
		Thr			Pro	
		Thr			Pro	



Pro	R	B
Proton	24	38
Neutron	18	35
Total=115	42	73

Bringing **Proline, the Activation Key**, in line with rest of the **Amino Acids**

Pro	R	B
Proton	23	39
Neutron	18	35
Total=115	41	74

As we investigate further, the **Signature** of **37** & **73** will keep re-occurring in these numerical structures.

For example concatenate the values **37** & **73** in this way as - **373**. Arranged as follows **(37)3** or **3(73)**.

What do we find? **373** is the **74th** prime number.

74 is 2 x **37** and the neighbour of **73**.

Add the last two words [6,7] **407** + **296** = **703** (**7, 3**) and

$$703 = 111 + 373 + 219 \quad \text{gives the digits}$$

$$[37 \times 3] \quad [373] \quad [3 \times 73] \quad 373 - 373 - 373$$

Previously we had **3773** revealing **7³ = 7 x 7 x 7 = 343**

343 also encodes **37** and **73**. How?

$$3(43) = 3(4+3) = 37 \quad (34)3 = (3+4)3 = 73$$

This value **343** equals the sum of **two Hebrew words**

וַיֹּאמֶר אֱלֹהִים

In summary this number **2701** and its prime number product of **37 x 73** is most definitely a **very Strong Signature**.

It is time, I think, that you should know what is **the translation** of these **7 Hebrew words**.

It is the sentence that the Astronauts read out from their Space Module. It is the most famous sentence known to man and it comes from the most ancient document we have.

It is from the first words of the Bible in **Genesis 1.1**

“In the beginning God created the Heaven and the Earth”

The 2 nd object	the 1 st object	Subject and verb				
הָאָרֶץ ₇	וְאֵת ₆	הַשָּׁמַיִם ₅	אֵת ₄	אֱלֹהִים ₃	בָּרָא ₂	בְּרֵאשִׁית ₁
296	407	395	401	86	203	913
Earth the	**and	Heavens the	**	God	created	beginning the In

Each day of **Creation** begins **“And God said”** value **343 = 7³** as above

86	וַיֹּאמֶר	אֱלֹהִים
257	86	257
343	God	said and

** Untranslatable Participle - the sign of the direct object

So this unique sentence sums to **2701**. The number of words are **7** and the number of letters are **28** [$27 + 01 = 28$].
Unusual ? Yes. Why ? The value **28** is the **7th Triangular Number**. At this point you need to know what is a **Triangular Number**. The following diagram will make it clear.

It is an arrangement as pictured below. The mathematical formula for triangular numbers is $\frac{1}{2}n(n + 1)$

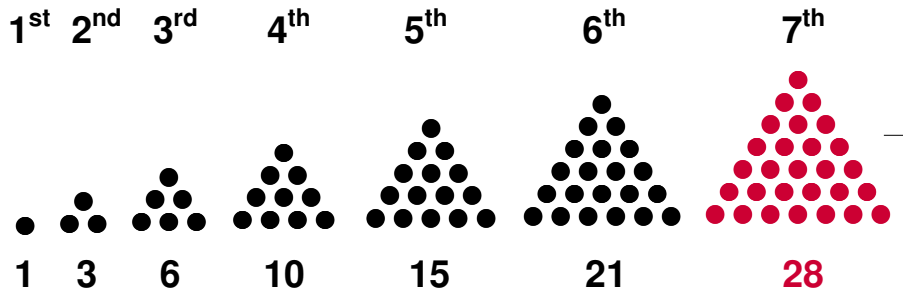

For example using ' $n = 7$ ' [number of words] we have $\frac{1}{2} \times 7 \times (7+1) = 28$ [number of letters], as above. Count the circles in each triangle to verify the formula.

The last two values $407 + 296$ ['and the Earth'] total to **703** and both values have **37** as the **Signature**.
 $407 = 11 \times 37$, $296 = 8 \times 37$.

We have then $2701 = 37 \times 73$ and $703 = 19 \times 37$.
 Now both these values are **triangular numbers**.
 $\frac{1}{2} \times 73 \times (73+1) = 2701$ and $\frac{1}{2} \times 37 \times (37+1) = 703$.

It turns out, as proved by Algebra, that **3 & 7** Are the only two values that can be combined in this way so as to produce the **reflective product** of two primes and a **triangular number** of one of the primes, i.e. 37×73 giving **2701**, and this product **2701** is also the **73rd** triangular number of one of the factors - **73**.
 Using **3 & 7** why should these profound Words in Genesis produce such **Mathematical Signature ?**

AAT Asn	GAT Asp	TAT Tyr	CAT His
AAC Asn	GAC Asp	TAC Tyr	CAC His
AAA Lys	GAA Glu	TAA Stop	CAA Gln
AAG Lys	GAG Glu	TAG Stop	CAG Gln
AGT Ser	GGT Gly	TGT Cys	CGT Arg
AGC Ser	GGC Gly	TGC Cys	CGC Arg
AGA Arg	GGA Gly	TGA Stop	CGA Arg
AGG Arg	GGG Gly	TGG Trp	CGG Arg
ATT Ile	GTT Val	TTT Phe	CTT Leu
ATC Ile	GTC Val	TTC Phe	CTC Leu
ATA Ile	GTA Val	TTA Leu	CTA Leu
ATG Met	GTG Val	TTG Leu	CTG Leu
ACT Thr	GCT Ala	TCT Ser	CCT Pro
ACC Thr	GCC Ala	TCC Ser	CCC Pro
ACA Thr	GCA Ala	TCA Ser	CCA Pro
ACG Thr	GCG Ala	TCG Ser	CCG Pro

The Blue inner rows

Codon	R	B	Total
Ser	31	74	105
Arg	100	74	174
Gly	1	74	75
Cys	47	74	121
Stop	0	0	0
Trp	130	74	204
Arg	100	74	174
Ile	57	74	131
Met	75	74	149
Val	43	74	117
Phe	91	74	165
Leu	57	74	131
Leu	57	74	131
Nucleons	789	888	1677

The Totals of the Nucleons for the **Inner** and **Outer Rows** we have:

The Green outer rows

Codon	R	B	Total
Asn	58	74	132
Lys	72	74	146
Asp	59	74	133
Glu	73	74	147
Tyr	107	74	181
Stop	0	0	0
His	81	74	155
Gln	72	74	146
Thr	45	74	119
Ala	15	74	89
Ser	31	74	105
Pro	41	74	115
Nucleons	654	814	1468

R B

Inner $789 + 888 = 1677$
Outer $654 + 814 = 1468$
Total $1443 + 1702 = 3145$



The same values as the Columns !
But everything is inverted ! Symmetrical
The values of the Columns interchanged with the values of the **Rows**, **Inner = Outer !**

$1443 = 39 \times 37$ both **Signatures**
 from John 1.1 (39), Gen 1.1 (37)

$1702 = 46 \times 37$ The words

'In the beginning God ... and the Earth'

DNA the code of life on Earth

$3145 = 85 \times 37$ Gen 1.1

All these values are **Biblical Signatures**
No random numbers here !

The Blue Inner Columns

AAT Asn	GAT Asp	TAT Tyr	CAT His
AAC Asn	GAC Asp	TAC Tyr	CAC His
AAA Lys	GAA Glu	TAA Stop	CAA Gln
AAG Lys	GAG Glu	TAG Stop	CAG Gln
AGT Ser	GGT Gly	TGT Cys	CGT Arg
AGC Ser	GGC Gly	TGC Cys	CGC Arg
AGA Arg	GGA Gly	TGA Stop	CGA Arg
AGG Arg	GGG Gly	TGG Trp	CGG Arg
ATT Ile	GTT Val	TTT Phe	CTT Leu
ATC Ile	GTC Val	TTC Phe	CTC Leu
ATA Ile	GTA Val	TTA Leu	CTA Leu
ATG Met	GTG Val	TTG Leu	CTG Leu
ACT Thr	GCT Ala	TCT Ser	CCT Pro
ACC Thr	GCC Ala	TCC Ser	CCC Pro
ACA Thr	GCA Ala	TCA Ser	CCA Pro
ACG Thr	GCG Ala	TCG Ser	CCG Pro

Codon	R	B	Total
Asp	59	74	133
Glu	73	74	147
Gly	1	74	75
Val	43	74	117
Ala	15	74	89
Tyr	107	74	181
Stop	0	0	0
Cys	47	74	121
Stop	0	0	0
Trp	130	74	204
Phe	91	74	165
Leu	57	74	131
Ser	31	74	105
Nucleons	654	814	1468

These triangular values are illustrated below.
Now the 37th (703) triangular number fits precisely inside the 73rd (2701) triangular number and sections off three more triangles - 36th (666) triangular number and 36 = 6 x 6

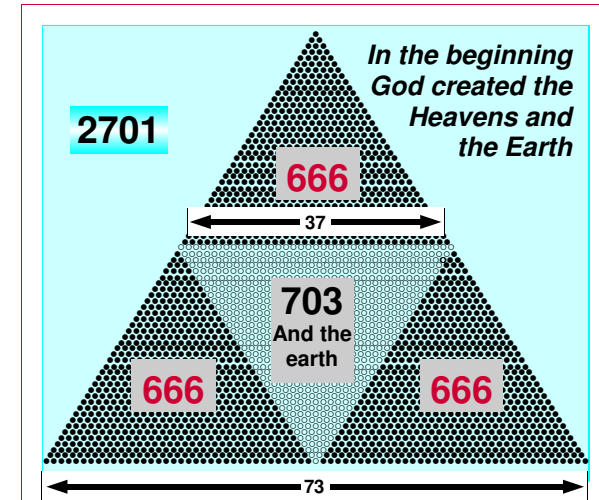

Totalling the Nucleons for the Inner and Outer Columns we have:

	R	B	
Outer	789 +	888 =	1677
Inner	654 +	814 =	1468
Total	1443 +	1702 =	3145



7 הארץ	6 ואת	5 השמים	4 את	3 אלהים	2 ברא	1 בראשית
296	407	395	401	86	203	913
Earth the	**and	Heavens the	**	God	created	beginning the In

888 = The Name "Jesus" Ἰησοῦς In Greek of the New Testament.

1443 = 39 x 37 both Signatures from John 1.1 (39), Gen 1.1 (37)

1702 = 46 x 37 The words "In the beginning God... and the Earth"

3145 = 85 x 37 Gen 1.1 37 x 73

814 = 22 x 814 = 2 x 407 = 'and' 407 = the 6th word of Gen 1.1

The numerical analysis is not what we would have expected !

Those who advocate Evolution (Random forces) did not expect this kind of Non Random Signature in DNA, least of all to the Bible's Signature in Genesis (37, 73) and John (39, 93).

NO Natural Selection remotely possible.

shCherbak now arranges the symmetry according to the Inner and Outer Rows.

The seven values can be partitioned into two groups. Words 1 - 5, ' In the beginning God created the Heavens ' adding the values together gives 1998 = 2 x 3³ x 37. Now 1³ + 9³ + 9³ + 8³ = 1971 = 3³ x 73 73 again. 1 + 9 + 9 + 8 = 3³ = 27 Sum of digits and 27 is a factor

913
203
86
401
395
1998

Also Words 6 - 7 'and the Earth' adding the values together gives 703 = 19 x 37 and 7³ + 0³ + 3³ = 370 = 37 x 10 7 + 0 + 3 = 10 Sum of digits and 10 is also a factor The sum 1 + 9 + 9 + 8 + 7 + 0 + 3 = 37 Signature of 37.

407
296
703

Letter (Shape of letter when written at the end of a	α	β	γ	δ	ε	ς	ζ	η	θ	ι	κ	λ
Numeric Value	1	2	3	4	5	6	7	8	9	10	20	30

μ	ν	ξ	ο	π	φ	ρ	ς	τ	υ	φ	χ	ψ	ω	Ϟ
40	50	60	70	80	90	100	200	300	400	500	600	700	800	900

The Greek Word λογος *Logos* contains
The Signature 30 + 7 + 3 + 70 + 200 = **373 (37)3 3(73)**

The 'Word' of God - Greek *Logos* is the title of **Jesus Christ** in the New Testament. We saw previously that **373** was from **Gen 1.1** and is the **74th** prime number. **74 = 2 x 37** and a neighbour of **73**.
Should we have expected the name Jesus Christ to be connected to Gen 1.1 ?

We will now investigate the numeric value in the Greek language of the actual name of the Son of God, Jesus Christ. Remember The New Testament is written Greek

The numeric values **Stigma ς = 6, Koppa φ = 90, Sampi Ϟ = 900** are attached to **three ancient Greek** (Phoenician) letters which are no longer included in the Greek alphabet and not used anywhere in **the New Testament** and they have become obsolete. **Stigma ς** for **6** is a ligature of the Greek letters "sigma" and "tau".

The lower case stigma is similar in appearance to final sigma (ς), but the top loop is larger, and extends to the right. Two arbitrary symbols were also added called respectively **Koppa φ**, for **90**, and **Sampi Ϟ**, for **900**. It has been attested in early Aeolic and Boeotian scripts, but became altogether extinct by pre-Classical times. **Koppa** was originally borrowed from the Phoenicians, who had **q** in their language

The Purines totals **629, 888** and **1517**

The Signature 37 factor of 888 = 'Jesus' is 37	Now 629 = 17 x 37 888 = 24 x 37 1517 = 41 x 37	The Signature 37
--	---	-------------------------

The value of the name **'Jesus'** = **888** New Testament
The value of the Words **'In the beginning...the Earth'** = **1517 Gen 1.1**



The Pyrimidines totals **814, 814** and **1628**

The Signature factors of 'Gen 1.1' , 'Jesus Christ' all 37 'Word' = 373	814 = 22 x 37 814 = 22 x 37 1628 = 44 x 37	814 duplicate Symmetry A None Random 814 = 2 x 407 = 2 x 11 x 37 = 'and' 407 = the 6th word of 'Gen 1.1'
---	---	---

Again the **Nucleons (814)** are **split equally** between the **Standard Block** and the **Side Chain**. **Purines symmetrical** with **Pyrimidines**

The Signature 37 encoded in the **DNA. 37** the **Signature of Creation**.

shCherbak's Third Symmetrical arrangement

This Third Symmetry is formed, by **Columns** and then by **Rows**.

Add the **Outer Columns** and then **The Inner Columns**.

AAT Asn	GAT Asp	TAT Tyr	CAT His
AAC Asn	GAC Asp	TAC Tyr	CAC His
AAA Lys	GAA Glu	TAA Stop	CAA Gln
AAG Lys	GAG Glu	TAG Stop	CAG Gln
AGT Ser	GGT Gly	TGT Cys	CGT Arg
AGC Ser	GGC Gly	TGC Cys	CGC Arg
AGA Arg	GGA Gly	TGA Stop	CGA Arg
AGG Arg	GGG Gly	TGG Trp	CGG Arg
ATT Ile	GTT Val	TTT Phe	CTT Leu
ATC Ile	GTC Val	TTC Phe	CTC Leu
ATA Ile	GTA Val	TTA Leu	CTA Leu
ATG Met	GTG Val	TTG Leu	CTG Leu
ACT Thr	GCT Ala	TCT Ser	CCT Pro
ACC Thr	GCC Ala	TCC Ser	CCC Pro
ACA Thr	GCA Ala	TCA Ser	CCA Pro
ACG Thr	GCG Ala	TCG Ser	CCG Pro

Green Outer Columns

Codon	R	B	Total
Asn	58	74	132
Lys	72	74	146
Ser	31	74	105
Arg	100	74	174
Ile	57	74	131
Met	75	74	149
Thr	45	74	119
His	81	74	155
Gln	72	74	146
Arg	100	74	174
Leu	57	74	131
Pro	41	74	115
Nucleons	789	888	1677

The **Second Symmetry** is based on splitting the **DNA** codons into the **Purines** and **Pyrimidines**. The **Purines** 'begin' with the codes **A** or **G**, the **Green Block** and The **Pyrimidines** 'begin' with the codes **C** or **T**, the **Blue Block**.

Technical: Purine Base Structure of **A** and **G**, **Adenine** and **Guanine** have 9 atoms that make up the fused rings (5 carbon, 4 nitrogen).

Pyrimidine Base Structure of **C** and **T**. **Cytosine** and **Thymine** have the 6 atoms that make up the fused rings (4 carbon, 2 nitrogen).

The Purines **The Pyrimidines**

AAT Asn	GAT Asp	TAT Tyr	CAT His
AAC Asn	GAC Asp	TAC Tyr	CAC His
AAA Lys	GAA Glu	TAA Stop	CAA Gln
AAG Lys	GAG Glu	TAG Stop	CAG Gln
AGT Ser	GGT Gly	TGT Cys	CGT Arg
AGC Ser	GGC Gly	TGC Cys	CGC Arg
AGA Arg	GGA Gly	TGA Stop	CGA Arg
AGG Arg	GGG Gly	TGG Trp	CGG Arg
ATT Ile	GTT Val	TTT Phe	CTT Leu
ATC Ile	GTC Val	TTC Phe	CTC Leu
ATA Ile	GTA Val	TTA Leu	CTA Leu
ATG Met	GTG Val	TTG Leu	CTG Leu
ACT Thr	GCT Ala	TCT Ser	CCT Pro
ACC Thr	GCC Ala	TCC Ser	CCC Pro
ACA Thr	GCA Ala	TCA Ser	CCA Pro
ACG Thr	GCG Ala	TCG Ser	CCG Pro

Codon	R	B	Total
Tyr	107	74	181
Stop	0	0	0
Cys	47	74	121
Stop	0	0	0
Trp	130	74	204
Phe	91	74	165
Leu	57	74	131
Ser	31	74	105

The Purines

Codon	R	B	Total
Asn	58	74	132
Lys	72	74	146
Ser	31	74	105
Arg	100	74	174
Ile	57	74	131
Met	75	74	149
Thr	45	74	119
Asp	59	74	133
Glu	73	74	147
Gly	1	74	75
Val	43	74	117
Ala	15	74	89
Nucleons	629	888	1517

Analysis on the next page

The Pyrimidines

His	81	74	155
Gln	72	74	146
Arg	100	74	174
Leu	57	74	131
Pro	41	74	115
Nucleons	814	814	1628

Jesus_Ιησους - Christ_Χριστος

$$10 + 8 + 200 + 70 + 400 + 200 = \underline{888} = 3 \times 8 \times 37 \text{ Jesus}$$

$$600 + 100 + 10 + 200 + 300 + 70 + 200 = \underline{1480} = 5 \times 8 \times 37 \text{ Christ}$$

The **Signature 37** has now appeared again in both names. The **Signature 37** is intrinsic to The Creation of Universe in **Gen 1.1** and in the **New Testament** we are told that **Jesus Christ** created all things as the **Word (373)** of God, "and God said" ($343 = 7^3$).

"All things were made through him and without him was not anything made that was made" John 1.3

$$\text{Jesus Christ} = 888 + 1480 = 2368 = 8 \times 8 \times 37 = 8 \times 296$$

Now **296** is word אָרֶץ 'the Earth' Gen 1.1

$$\text{And sum of the digits } 8 + 8 + 8 + 1 + 4 + 8 + 0 = 37$$

Jesus Christ is the **Saviour** of the Earth & its inhabitants.

I will remind you again, that the time when **Gen 1.1** was written, the values of the letters were not known. This implies that the final symmetry of the numerics must have been known before the sentence was written, but this is impossible because the values are unknown at the time of the writing the words, unless of course you are the designer of the whole structure. This is the **Eternal God** who knows everything from **the beginning to the end**.

What you have seen has only scratched the surface of this **embedded signature of 37**, but I hope you have been impressed by what I have shown you and the display of **Mathematical symmetry**. I hope you can see that numbers are **not a random** selection of values, but have been carefully chosen by the **Mathematical equations**.

We will now turn our attention to the Gospel of John. The scripture we will investigate is **John 1.1**, the New Testament equivalent of **Gen 1.1**

Εν	αρχ	η	ην	ο	λογος
<i>In the beginning was the Word</i>					
55	719	58	70	373	
5,50	1,100,600,8,10	8,50	70	30,70,3,70,200	
και	ο	λογος	ην	προς	τοις
<i>and the Word was with the God</i>					
31	70	373	58	450	420
20,1,10	70	30,70,3,70,200	8,50	80,100,70,200	300,70,50
9,5,70,50					
και	θεος	ην	ο	λογος	
<i>and God was the Word</i>					
31	284	58	70	373	
20,1,10	9,5,70,200	8,50	70	30,70,3,70,200	

Peter Bluer

The value of **John 1.1** is $3627 = 13 \times 3 \times 3 \times 31 = 39 \times 93$.
 The factors are **reflective**, exactly as **Gen 1.1** but they are not triangular as expected ! **Here is the ingenious part.**

If we join **Gen 1.1** to **John 1.1** by addition

i.e. $2701 + 3627 = 6328$ Hebrew and Greek

Now we find that **6328** is the **112th** triangular number.

The value **3627** **John 1.1** is also generated from the same linear equation used in **Gen 1.1** with the values of $x = 93$ (3×31) $y = 31$ the very factors of **John 1.1**

$$F(x, y) = 37x + 6y \quad F(93, 31) = 37 \times 93 + 6 \times 31 = 3627$$

This triangular key locks **John 1.1** to **Gen 1.1** and they were written thousands of years apart. Impossible to conspire.

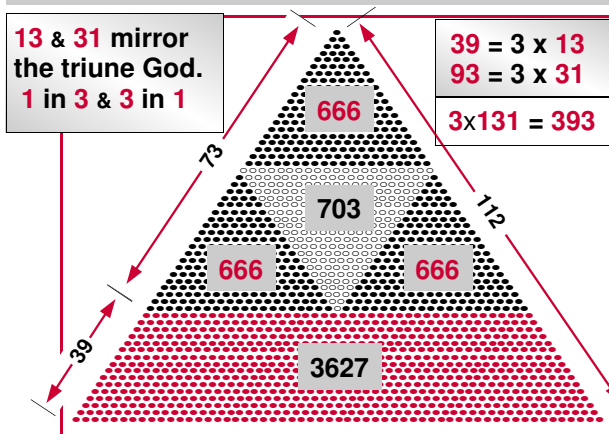

The value of **1998** (3×666) are the words 'In the beginning God created the Heavens'
703 are the words 'and the Earth'
3627 are all the words of **John 1.1**

AAT Asn	GAT Asp	TAT Tyr	CAT His
AAC Asn	GAC Asp	TAC Tyr	CAC His
AAA Lys	GAA Glu	TAA Stop	CAA Gln
AAG Lys	GAG Glu	TAG Stop	CAG Gln
AGT Ser	GGT Gly	TGT Cys	CGT Arg
AGC Ser	GGC Gly	TGC Cys	CGC Arg
AGA Arg	GGA Gly	TGA Stop	CGA Arg
AGG Arg	GGG Gly	TGG Trp	CGG Arg
ATT Ile	GTT Val	TTT Phe	CTT Leu
ATC Ile	GTC Val	TTC Phe	CTC Leu
ATA Ile	GTA Val	TTA Leu	CTA Leu
ATG Met	GTG Val	TTG Leu	CTG Leu
ACT Thr	GCT Ala	TCT Ser	CCT Pro
ACC Thr	GCC Ala	TCC Ser	CCC Pro
ACA Thr	GCA Ala	TCA Ser	CCA Pro
ACG Thr	GCG Ala	TCG Ser	CCG Pro

The Symmetry of the number of **Nucleons** are shared equally (**1110**) between **the Standard Block B** and **the Side Chain R**.

Codon	R	B	Total
Asn	58	74	132
Lys	72	74	146
Ser	31	74	105
Arg	100	74	174
Ile	57	74	131
Met	75	74	149
Asp	59	74	133
Glu	73	74	147
Tyr	107	74	181
Stop	0	0	0
Cys	47	74	121
Stop	0	0	0
Trp	130	74	204
Phe	91	74	165
Leu	57	74	131
His	81	74	155
Gln	72	74	146
Nucleons	1110	1110	2220

The surprise is that **the Signature 37** is again encoded. **A None Random** arrangement.

The Signature factor of 'Gen 1.1', 'Jesus Christ', 'Word' is **37**

$$\begin{aligned} R \quad 1110 &= 3 \times 10 \times 37 \\ B \quad 1110 &= 3 \times 10 \times 37 \\ 2220 &= 3 \times 20 \times 37 \end{aligned}$$



180°
Rotational
Symmetry

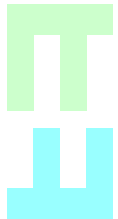

The value of the Words '*In the beginning...the Earth*' = **2220**

The **Start** instruction is the sequence **ATG**, the Amino acid **Methionine** but the **Stop** instruction **TAA**, **TAG** and **TGA** contribute nothing to the Amino acid count.

It is remarkable, the **Signature** of **37** is a part of this **rotational symmetry**. **shCherbak** does not relate any of **his numerical discoveries 37 and 73** to the Biblical values **37** and **73**.

We will now investigate **shCherbak's Second Symmetry**

The number of **Nucleons** in the **Standard Block [B]** of **19 Amino acids** have the value of **74 = 2 x 37**. Remember **74 is the neighbour of 73 Gen 1.1 (37 x 73)**. Also the number of **Protons** in the **Standard Block** of the **19 amino acids** has the value of **39 = 3 x 13 John 1.1 (39 x 93)**.

3 is the sign of Deity and is also the **3 lettered coding unit (Codons)**. Again the value of **73 [Gen 1.1]** is encoded in the **single Amino acid Proline**. Now If we borrow a **Proton** from **the Radical** of **Proline** and put it in the **Standard Block** it **systemizes the 20 Amino acids***, an amazing phenomena occurs in **the distribution of the Nucleons**.

shCherbak calls **Proline** the **Activation Key** for the **20 Acids**.

shCherbak's First Symmetry

shCherbak arranged the **Amino acids** into 2 groups. Those **4 Codons** that code for **the same Amino acid** are shaded **Blue (in red)** and the rest of the Codons that do not code in groups of 4, are shaded **Green**.

The **Green** and **Blue** blocks can be transformed by **rotation of 180°**

Table for the Blue Block

AAT Asn	GAT Asp	TAT Tyr	CAT His
AAC Asn	GAC Asp	TAC Tyr	CAC His
AAA Lys	GAA Glu	TAA Stop	CAA Gln
AAG Lys	GAG Glu	TAG Stop	CAG Gln
AGT Ser	GGT Gly	TGT Cys	CGT Arg
AGC Ser	GGC Gly	TGC Cys	CGC Arg
AGA Arg	GGA Gly	TGA Stop	CGA Arg
AGG Arg	GGG Gly	TGG Trp	CGG Arg
ATT Ile	GTT Val	TTT Phe	CTT Leu
ATC Ile	GTC Val	TTC Phe	CTC Leu
ATA Ile	GTA Val	TTA Leu	CTA Leu
ATG Met	GTG Val	TTG Leu	CTG Leu
ACT Thr	GCT Ala	TCT Ser	CCT Pro
ACC Thr	GCC Ala	TCC Ser	CCC Pro
ACA Thr	GCA Ala	TCA Ser	CCA Pro
ACG Thr	GCG Ala	TCG Ser	CCG Pro

Codon	R	B	Total
Thr	45	74	119
Gly	1	74	75
Val	43	74	117
Ala	15	74	89
Ser	31	74	105
Arg	100	74	174
Leu	57	74	131
Pro	41	74	115
Nucleons	333	592	925

Remember **Gen 1.1 is 37 x 73**.

$$R \quad 333 = 9 \times 37 \quad 74 = 73 + 1$$

$$B \quad 592 = 16 \times 37 \quad 37 \text{ reflects } 73$$

$$925 = 25 \times 37 \quad 74 = 2 \times 37$$

Now **74** and **73** by neighbourhood with **Proline** encodes the value **73**.

It is interesting to see **Pythagoras** in the values **9,16 & 25**,

$$3^2 + 4^2 = 5^2 \text{ called the Egyptian Triangle.}$$

The **Genesis Signature** of **37** is **the Same Signature** of **37** in the **Genetic code**.

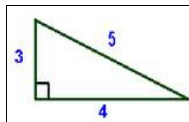

We will now investigate **phenomena** of **the Green Block**.

* Jean-Yves Boulay has an alternative solution call the '**Proline Hypothesis**'

13	+	26	+	102	+	26	+	541	+	410	=	1118
4,8,1		5,6,5,10		6,50,10,5,30,1		5,6,5,10		30,1,200,300,10		70,40,300		
אחד		יהוה		אלהינו		יהוה		ישראל		שמע		
ONE	is	LORD	the	GOD	our	LORD	the	Israel	O	Hear		

The Hebrew, **The LORD** is יהוה "Yahweh" the **Divine Name**

The value of this Sacred Name is **26 = 2 x 13** which has

'**ONE**' אחד (13), the **Signature** embedded in it.

The **numeric values** were only defined in **200 BC**

This Scripture is called "**The She'ma**" **Deut 6.4**

'**Hear O Israel the LORD our GOD the LORD is ONE**'

The **Signature** of **1118** is **13 x 86**.

Now **13** is the value of **the Hebrew אחד = ONE**.

86 is the value of **אלהים = GOD**.

Thus the **Total** value of the sentence **mirrors** the meaning of the sentence, that **GOD** is **Absolutely**

"**One [13] God [86]**".

The neighbour of **1118** is **1119 = 3 x 373 = 'Word' John 1.1**

This linking of the '**Shema**' of **One God** with the **Word of God** clearly defines **the Deity** of **The Lord Jesus Christ**

The equation **37x + 6y** defines **Gen 1.1, John 1.1 & Deut 6.4**

Gen 1.1 Signatures **37 x 73 = 2701**

$$F(x,y) = 37x + 6y \quad F(73,0) = 37 \times 73 + 6 \times 0 = 2701$$

John 1.1 Signatures **3 x 13 x 31 x 3 = 39 x 93**

$$F(x,y) = 37x + 6y \quad F(93,31) = 37 \times 93 + 6 \times 31 = 3627$$

Deut 6.4 Signatures = **13 x 86 = 26 x 43**

$$F(x,y) = 37x + 6y \quad F(26,26) = 37 \times 26 + 6 \times 26 = 1118$$

What now follows is the results of **the work of Scientists** who have examined **the numerical structure** of **DNA** and its **Amino Acid** components from the standpoint of **Mathematics**.

The Amino Acids **Protons** and **Neutrons** have been classified and counted. These findings have been analysed on the basis of **Arithmetic and Prime numbers**.

The results are quite a shock as they show a remarkable structure based on the prime numbers **37, 73** and **39 = 3 x 13**.

You have just read the previous pages of **the Biblical Signature** of **37, 73** and **39 (3 x 13)** embedded in **Genesis** and **the Gospel of John**.

So to find these **same numbers** are then displayed in **the molecules of DNA** is **no surprise** to us who **know** that **God is the Author of both**.

Scientists have shown, time and time again, that **the Universe** we live in has **Mathematics** as its **building blocks**.

It is safe to say that these Scientists were NOT trying to prove that the Bible contains the Truth of our Existence.

Please remember that the Hebrew of Genesis was written down 4000 years before the value of the letters were known.

The expansion of **the Genome** into the **SETI PROJECT** using **DNA** as an alternative is the proposal of **Mathematical Evolutionary Biologists** of **Prof Vladimir I. shCherbak** and his associates.

It has been in the News recently that **DNA** has been used at the present time to store **digital information** because it is the **most stable and efficient** means of storage known to mankind.

Because **DNA** is composed of discreet components, its noise immunity (non corruptibility) is **very high**. It can be coded to store data using our digital form of storage and can remain unchanged probably indefinitely.

This means it could contain a **Signature** of **the intelligence source** that created its structure.

Because it contains this **Signature**, **DNA** has been put forwarded by these **Scientists** as created by an **intelligent source** because the **Signature** is **non random** and **the Signature** is embedded with **Positional Arithmetic** (Hundreds, Tens, Unit) using the **Decimal System** and with the invention of **the Concept of Zero**. **Positional Zero** is a **latecomer** to our use of numbers (There is no year zero, dates change from BC 1 TO AD 1).

The Signature which is sometimes called a **Signal** has **the hallmark of artificiality** i.e. **NOT created by natural processes**.

A Note on **the nature of Probability** and how **we Humans** detect that an object we come across has been **design by an Intelligent Source**.

First let me deal with probability. Statisticians have **tests** to examine Hypotheses to see if there is **any significance** in the data or whether not the data has been caused by **natural means** or is it caused **artificially** by an intelligent source, **human or otherwise**. This is **crucial issue** in the debate on **Creation** and **Evolution**.

Sometimes **Creationists** like to say that **Some Object in Nature** must have been **Created** because **the chances** of the object coming into existence by **Random methods** has a probability of say of 10^{-50} **thus proving** it must have been **Created**. This is a false argument. **Why ?**

As an **illustration** suppose we have **10,000 building bricks** in a crate held up in mid air by a crane. Let us imagine the cable on the crane **breaks** and all the bricks fall out to the earth and end up as a **random pile** in every orientation possible. Now the chance of that happening again where all the bricks fall and land in **exactly the same position** and **orientation** as the previous fall, is $10^{-(\text{infinity})}$.

Therefore because the chances of the event being **impossible to duplicate** does **not mean** the first event is **a product of intelligent design**. So a **low probability** is **not the complete story**.

The reason **we know** and just not believe that a watch is **designed**, we give **two scientific reasons**.

The First is of course **the zero probability** of less than 10^{-50} and the **Second reason** is that the watch contains **function, information**, proving that **the watch** is created from **an intelligent source**.

In **information technology** devices **Transmit Codes, encoding information** but this only has **any meaning if there** is a **receiver** of the **codes** for that **information**. Without **the receiver the codes** are just **random signals**. For **random chance** to generate **Transmitter** and a **Receiver simultaneously** is the **most absurd, unintelligent, mindless idea** that a person could believe.

It is the same as generating **a computer program** full of Random codes (instructions) with no relationship to each other and expecting another **Random selection of codes** in **the Second program** to interpret **the First** set of **Random codes** and generate some **meaningful** function.

Remember **Atheism** is **Absolutely Totally dependant on Evolution** for **its survival** thus **avoiding** the concept of **the Creator**. If this **Theory** (**NOT** in the **factual** sense of the Word) did not provoke **the existence** of **the Deity** then these **Scientists** would have **Scrapped the Theory** of **Evolution** and it would **NEVER** have seen **the light of Day**.

Carbon-12 is the more abundant of the two stable isotopes of the element carbon, accounting for 98.89% of carbon; it contains 6 protons, 6 neutrons, and 6 electrons. **Carbon-12** is of particular importance as it is used as the standard from which atomic masses of all nuclides are measured: its mass number is by **definition 12**.

The following table gives the molecular masses relative to **Carbon-12** of the **20 canonical amino acids**.

Alanine	[Ala]	89.0935	Lysine	[Lys]	146.1882
Arginine	[Arg]	174.2017	Methionine	[Met]	149.2124
Asparagine	[Asn]	132.1184	Phenylalanine	[Phe]	165.1900
Aspartic Acid	[Asp]	133.1032	Proline	[Pro]	115.1310
Cysteine	[Cys]	121.1590	Serine	[Ser]	105.0930
Glutamic Acid	[Glu]	147.1299	Threonine	[Thr]	119.1197
Glutamine	[Gln]	146.1451	Tryptophan	[Trp]	204.2262
Glycine	[Gly]	75.0669	Tyrosine	[Tyr]	181.1894
Histidine	[His]	155.1552	Valine	[Val]	117.1469
Isoleucine	[Ile]	131.1736			2738.0169
Leucine	[Leu]	131.1736			

The total **integer Molecular mass** of the **20 amino acids** is **2738**.

Bible Mathematics is concerned with integer values (whole numbers).

The integer total is **2738**.

The Biblical value of **Gen 1.1**

“In the beginning God created the Heavens and the Earth”

is **37 x 73 = 2701**.

Also **Gen 1,2**

“the Spirit of God moved upon the face of the waters”

is **37 x 37 = 1369**.

The total molecular weight **2738** can be analysed as follows:

Gen 1.1 **2701 (37 x 73) + 37 = 2738,**

or **37 x (73 + 1) = 2738,**

and also **Gen 1.2 = 1369 2 x 1369 = 2 x 37 x 37 = 2738.**

The Evolutionary Biological Scientists who have researched this numerical analysis of **DNA**, are **NOT Biblical Creationists**

The properties of **DNA** inside the **cell** are:

1. Duplication, 2. Reproduction, 3. Self Diagnostic 4. Self Repairing.

As long as the **DNA** remains inside the **fantastic molecular machinery** of the **cell** with it's range of up to **100,000 different proteins**, which will execute the **DNA** Chemical Program. Outside the Cell, the **DNA** is **completely useless**. This means that, the thousands of **Protein Machines in the Cell** are required first, but the problem is that the **Protein Machinery** is also made by the **DNA chemical instructions**.

Thus the process never gets started without an external source to create its origin. This was **the problem** when **the first computer was designed**.

The Computer had to be built by **man** before the digital program could run. This problem of **the start up** i.e. **the beginning** is called the **bootstrap** principle. Therefore it has been proposed by **these highly reputable Scientists** that **the Earth was seeded** millions of years ago to **account for life** on our planet. Unfortunately **these Scientists** do not account for **the Machinery of the cell** which is **infinitely** more complex than the **DNA** itself.

The scientists **NEVER** appeal to **the concept of God** as we accept God.

They call the **DNA Creator** ‘**What ever it was**’ thus avoiding the word ‘**God**’ We will now illustrate a method of deciding whether or not a group of apparently random numbers are not actually Random.

These selected values seem to be unrelated but under close inspection they are shown **not to be Random**.

Apparent Random Numbers: 183 368 423 208 239 276 319

First what can we do to investigate them. May I suggest that we put them in ascending order. **183 208 239 276 319 368 419**

(1) (2) (3) (4) (5) (6) (7)

We can determined that they are **not Random** values because turns out that the Equation shown below calculates these values precisely.

$$3n^2 + 16n + 164$$

All these values can be generated thus

Examples $3 \times (1)^2 + 16 \times 1 + 164 = 183$

$$3 \times (3)^2 + 16 \times 3 + 164 = 239$$

$$3 \times (7)^2 + 16 \times 7 + 164 = 419$$

This kind of solution is practiced by those who want to find out if there is a **Mathematical logic** that exists between **apparently Random values**.

These Scientists use **this Logic of detection** under **various criteria** to determine if Structures are **Artificial** and not **Natural** occurrences.

Classification of Amino Acids

The following classification of Amino acids were given by the **Mathematical Evolutionary Biologist Professor Miloje M. Rakočević** [not a Creationist]. This classification has been **peer reviewed** in his Scientific Paper¹. The values in the final totals are to the nearest Integer [whole numbers] as **Bible Numerics** is constructed in Integers only.

Aspartic Acid 133.1032	Asparagine 132.1184	Alanine 89.0935	Leucine 131.1736	485.4887
Arginine 174.2017	Phenylalanine 165.1900	Proline 115.1310	Isoleucine 131.1736	585.6963
Lysine 146.1882	Tyrosine 181.1894	Threonine 119.1197	Methionine 149.2124	595.7097
Histidine 155.1552	Tryptophan 204.2262	Serine 105.0930	Cysteine 121.1590	585.6334
Glutamic Acid 147.1299	Glutamine 146.1451	Glycine 75.0669	Valine 117.1469	485.4888
755.7782	828.8691	503.5041	649.8655	2738.0169

133.1032	132.1184	89.0935	131.1736	485.4887
174.2017	165.1900	115.1310	131.1736	585.6963
146.1882	181.1894	119.1197	149.2124	595.7097
155.1552	204.2262	105.0930	121.1590	585.6334
147.1299	146.1451	75.0669	117.1469	485.4888
755.7782	828.8691	503.5041	649.8655	2738.0169

This side Analysis is on the next page.

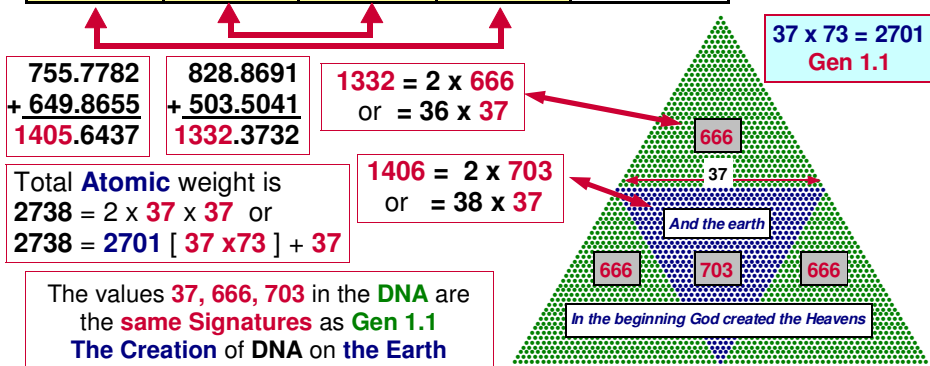

1. <http://www.arxiv4.library.cornell.edu/abs/0903.4110>

Aspartic Acid 133.1032	Asparagine 132.1184	Alanine 89.0935	Leucine 131.1736	485.4887
Arginine 174.2017	Phenylalanine 165.1900	Proline 115.1310	Isoleucine 131.1736	585.6963
Lysine 146.1882	Tyrosine 181.1894	Threonine 119.1197	Methionine 149.2124	595.7097
Histidine 155.1552	Tryptophan 204.2262	Serine 105.0930	Cysteine 121.1590	585.6334
Glutamic Acid 147.1299	Glutamine 146.1451	Glycine 75.0669	Valine 117.1469	485.4888
755.7782	828.8691	503.5041	649.8655	2738.0169

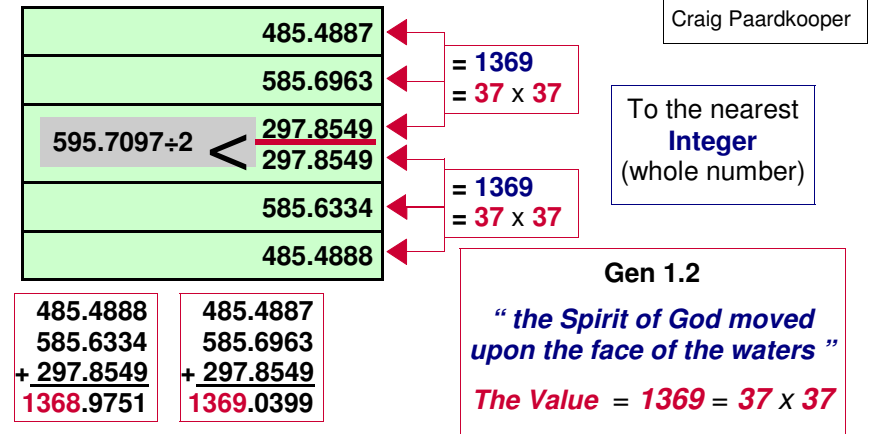

The prolific factor **37** from 'Gen 1.1' (37×73) and the name of the **Messiah 'Jesus'** ($888, 24 \times 37$) '**Christ**' ($1480, 40 \times 37$) is a very ingeniously method of encoding this **Signature** of **37** in this table.

The total value of $2738 = 2 \times 37 \times 37$.

The Symmetry over the **four columns**, inner and outer, produces the Biblical values of **666** (18×37) and **703** (19×37)

$3 \times 666 = 1998 =$ "In the beginning God created the Heavens"

703 = "and the Earth" Now $666 + 703 = 1369$ (37×37)

$2701 = 37 \times 73$

$1369 =$ "the Spirit of God moved upon the face of the waters".

This is the **Signature** of **37** encoded at **Creation**. This elegant numerical structure is **unalterable**. It has both vertical and Horizontal Symmetry.